

English  
Français  
Deutsch  
Italiano  
Español  
Português  
Nederlands  
Norsk  
Dansk  
Svenska  
Suomi  
Русский  
Polski  
Magyar  
Čeština  
Slovenčina  
Slovenski  
Hrvatski  
Română  
Български  
Eesti  
Latviski  
Lietuviškai  
Ελληνικά  
Türkçe  
日本語  
한국어  
繁體中文  
简体中文  
Bahasa Indonesia  
ไทย

# Contents



# Aspire 5745/5553 Series

## Quick Guide

© 2010 All Rights Reserved.

Aspire 5745/5553 Series Quick Guide  
Original Issue: 03/2010

Aspire 5745/5553 Series Notebook PC

Model number: \_\_\_\_\_

Serial number: \_\_\_\_\_

Date of purchase: \_\_\_\_\_

Place of purchase: \_\_\_\_\_

# First things first

We would like to thank you for making an Acer notebook your choice for meeting your mobile computing needs.

## Your guides

To help you use your Acer notebook, we have designed a set of guides:

First off, the **Just for Starters...** poster helps you get started with setting up your computer.

The **Aspire Series Generic User Guide** contains useful information applying to all models in the Aspire product series. It covers basic topics such as using the keyboard and audio, etc. Please understand that due to its nature, the **Generic User Guide** as well as the **AcerSystem User Guide** mentioned below will occasionally refer to functions or features which are only contained in certain models of the series, but not necessarily in the model you purchased. Such instances are marked in the text with language such as "only for certain models".

The **Quick Guide** introduces you to the basic features and functions of your new computer. For more on how your computer can help you to be more productive, please refer to the **AcerSystem User Guide**. This guide contains detailed information on such subjects as system utilities, data recovery, expansion options and troubleshooting. In addition it contains warranty information and the general regulations and safety notices for your notebook. It is available in Portable Document Format (PDF) and comes preloaded on your notebook. Follow these steps to access it:

- 1 Click on  **Start > All Programs > AcerSystem.**
- 2 Click on **AcerSystem User Guide.**



.....

**Note:** Viewing the file requires Adobe Reader. If Adobe Reader is not installed on your computer, clicking on **AcerSystem User Guide** will run the Adobe Reader setup program first. Follow the instructions on the screen to complete the installation. For instructions on how to use Adobe Reader, access the **Help and Support** menu.







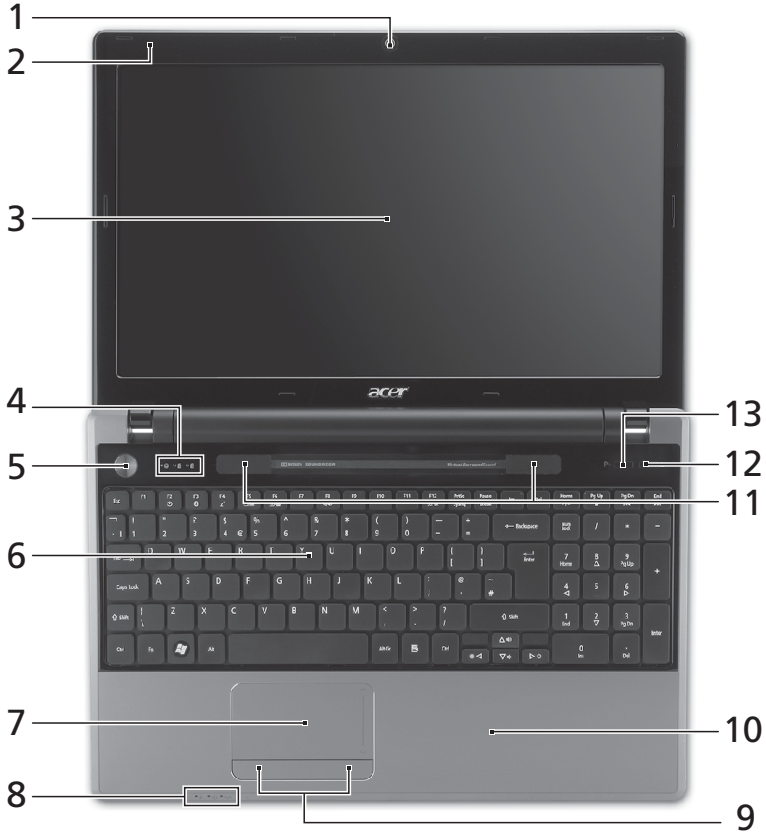

# Your Acer notebook tour

After setting up your computer as illustrated in the poster, let us show you around your new Acer notebook.

## Top view



#	Icon	Item	Description
1		Acer Crystal Eye webcam	Web camera for video communication. (only for certain models)
2		Microphone	Internal microphone for recording sound.















#	Icon	Item	Description
3		Display screen	Also called Liquid-Crystal Display (LCD), displays computer output (configuration may vary by model).
4		HDD indicator	Indicates when the hard disk drive is active.
		Num Lock indicator	Lights up when Num Lock is activated.
		Caps Lock indicator	Lights up when Caps Lock is activated.
5		Power button	Turns the computer on and off.
6		Keyboard	For entering data into your computer.
7		Touchpad	Touch-sensitive pointing device which functions like a computer mouse.
8		Power indicator <sup>1</sup>	Indicates the computer's power status.
		Battery indicator <sup>1</sup>	Indicates the computer's battery status. <b>1. Charging:</b> The light shows amber when the battery is charging. <b>2. Fully charged:</b> The light shows blue when in AC mode.
		Communication indicator <sup>1</sup>	Indicates the computer's wireless connectivity device status.
9		Click buttons (left and right)	The left and right buttons function like the left and right mouse buttons.
10		Palmrest	Comfortable support area for your hands when you use the computer.
11		Speakers	Left and right speakers deliver stereo audio output.
12		Optical drive eject button	Ejects the optical disk from the drive.
13	<b>P</b>	Programmable key	User-programmable. (only for certain models)
		PowerSmart key	Puts your computer into power-saving mode. (only for certain models)

1. The front panel indicators are visible even when the computer cover is closed up.

## Hotkeys

The computer employs hotkeys or key combinations to access most of the computer's controls like screen brightness and volume output.

To activate hotkeys, press and hold the **<Fn>** key before pressing the other key in the hotkey combination.

Hotkey	Icon	Function	Description
<b>&lt;Fn&gt; + &lt;F3&gt;</b>		Communication key	Enables / disables the computer's communication devices. (Communication devices may vary by configuration.)
<b>&lt;Fn&gt; + &lt;F4&gt;</b>		Sleep	Puts the computer in Sleep mode.
<b>&lt;Fn&gt; + &lt;F5&gt;</b>		Display toggle	Switches display output between the display screen, external monitor (if connected) and both.
<b>&lt;Fn&gt; + &lt;F6&gt;</b>		Display off	Turns the display screen backlight off to save power. Press any key to return.
<b>&lt;Fn&gt; + &lt;F7&gt;</b>		Touchpad toggle	Turns the internal touchpad on and off.
<b>&lt;Fn&gt; + &lt;F8&gt;</b>		Speaker toggle	Turns the speakers on and off.
<b>&lt;Fn&gt; + &lt;⇧&gt;</b>		Brightness up	Increases the screen brightness.
<b>&lt;Fn&gt; + &lt;⇩&gt;</b>		Brightness down	Decreases the screen brightness.
<b>&lt;Fn&gt; + &lt;⇧&gt;</b>		Volume up	Increases the sound volume.
<b>&lt;Fn&gt; + &lt;⇩&gt;</b>		Volume down	Decreases the sound volume.
<b>&lt;Fn&gt; + &lt;Home&gt;</b>		Play/Pause	Play or pause a selected media file.
<b>&lt;Fn&gt; + &lt;Pg Up&gt;</b>		Stop	Stop playing the selected media file.
<b>&lt;Fn&gt; + &lt;Pg Dn&gt;</b>		Previous	Return to the previous media file.
<b>&lt;Fn&gt; + &lt;End&gt;</b>		Next	Jump to the next media file.





## Closed front view



#	Icon	Item	Description
1		Multi-in-1 card reader	Accepts Secure Digital (SD), MultiMediaCard (MMC), Memory Stick (MS), Memory Stick PRO (MS PRO), xD-Picture Card (xD). <b>Note:</b> Push to remove/install the card. Only one card can operate at any given time.







## Right view

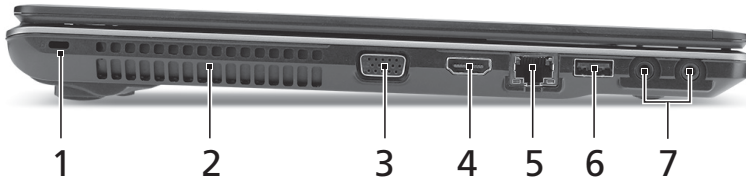

#	Icon	Item	Description
1		USB 2.0 port	Connect to USB 2.0 devices (e.g., USB mouse, USB camera).
2		Optical drive	Internal optical drive; accepts CDs or DVDs.
3		Optical disk access indicator	Lights up when the optical drive is active.
4		Emergency eject hole	Ejects the optical drive tray when the computer is turned off. <b>Note:</b> Insert a paper clip to the emergency eject hole to eject the optical drive tray when the computer is off.
5		DC-in jack	Connects to an AC adapter.





## Left view

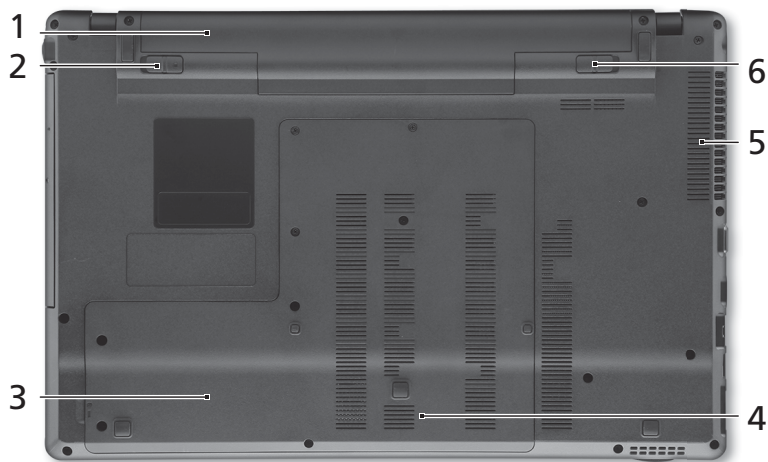

#	Icon	Item	Description
1		Kensington lock slot	Connects to a Kensington-compatible computer security lock.
2		Ventilation slots	Enable the computer to stay cool, even after prolonged use.
3		External display (VGA) port	Connects to a display device (e.g., external monitor, LCD projector).
4		HDMI port	Supports high definition digital video connections.
5		Ethernet (RJ-45) port	Connects to an Ethernet 10/100/1000-based network.
6		USB 2.0 port	Connect to USB 2.0 devices (e.g., USB mouse, USB camera).
7		Microphone jack	Accepts inputs from external microphones.
		Headphones/speaker/line-out jack with SPDIF support	Connects to audio line-out devices (e.g., speakers, headphones).

## Base view



#	Icon	Item	Description
1		Battery bay	Houses the computer's battery pack.
2		Battery lock	Locks the battery in position.
3		Hard disk bay	Houses the computer's hard disk (secured with screws).
4		Memory compartment	Houses the computer's main memory.
5		Ventilation slots and cooling fan	Enable the computer to stay cool, even after prolonged use. <b>Note:</b> Do not cover or obstruct the opening of the fan.
6		Battery release latch	Releases the battery for removal.

## Environment

---

- Temperature:
    - Operating: 5 °C to 35 °C
    - Non-operating: -20 °C to 65 °C
  - Humidity (non-condensing):
    - Operating: 20% to 80%
    - Non-operating: 20% to 80%
- 



.....

**Note:** The specifications listed above are for reference only. The exact configuration of your PC depends on the model purchased.

# Gamme Aspire 5745/5553

Guide rapide

© 2010 Tous droits réservés.

Guide rapide de la gamme Aspire 5745/5553

Première publication : 03/2010

Ordinateur notebook de la gamme Aspire 5745/5553

Modèle : \_\_\_\_\_

No. de série : \_\_\_\_\_

Date d'achat : \_\_\_\_\_

Lieu d'achat : \_\_\_\_\_

# Pour commencer

Nous désirons vous remercier d'avoir fait d'un notebook Acer votre choix pour répondre à vos besoins informatiques mobiles.

## Vos guides

Pour vous aider à utiliser votre notebook Acer, nous avons conçu plusieurs guides :

Tout d'abord, le poster **Pour partir du bon pied...** vous aide à configurer votre ordinateur.

Le **Guide utilisateur générique de la gamme Aspire** contient des informations utiles qui s'appliquent à tous les modèles de la gamme des produits Aspire. Il couvre les sujet de base, telles que l'utilisation du clavier, du son, etc. Il faut comprendre que du fait de sa nature, le **Guide utilisateur générique** ainsi que le **AcerSystem User Guide** mentionné ci-dessous fera référence parfois à des fonctions ou des caractéristiques qui ne sont contenues que dans certains modèles de la gamme, mais pas nécessaire dans le modèle que vous avez acheté. Ces cas sont marqués dans le texte avec des mentions telles que « seulement pour certains modèles ».

Le **Guide rapide** présente les fonctionnalités et fonctions de base de votre ordinateur. Pour plus d'information sur l'aide que peut vous apporter pour être plus productif, veuillez vous reporter à **AcerSystem User Guide**. Ce guide contient des informations détaillées sur des sujets tels que les utilitaires systèmes, la récupération des données, les options d'extension et le dépannage. De plus, il contient des informations de garantie et les réglementations générales et les avis de sécurité pour votre notebook. Il est disponible au format PDF (Portable Document Format) et est préchargé sur votre notebook. Procédez comme suit pour y accéder :

- 1 Cliquez sur  **Démarrer** > **Tous les programmes** > puis **AcerSystem**.
- 2 Cliquez sur **AcerSystem User Guide**.



.....

**Remarque :** L'affichage du fichier nécessite Adobe Reader. Si Adobe Reader n'est pas installé dans votre ordinateur, le clic sur **AcerSystem User Guide** va exécuter le programme d'installation d'Adobe Reader. Suivez les instructions à l'écran pour terminer l'installation. Pour des instructions sur l'utilisation de Adobe Reader, accédez au menu **Aide et Support**.

# Votre visite guidée du notebook Acer





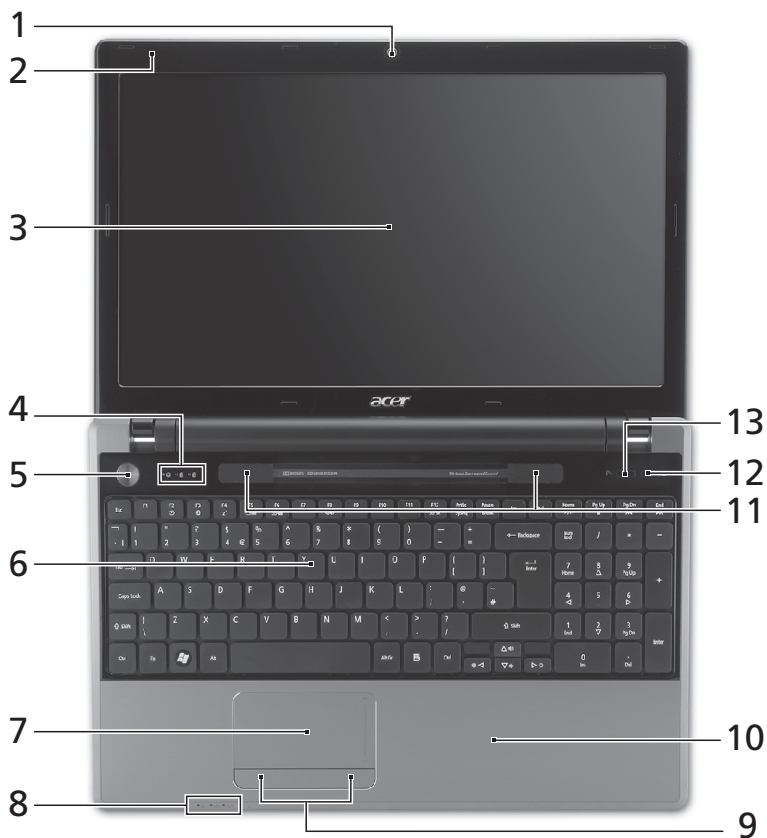





Après avoir configuré votre ordinateur comme illustré dans le poster, nous allons vous faire explorer votre nouveau notebook Acer.

## Vue supérieure



#	Icône	Élément	Description
1		Webcam Acer Crystal Eye	Webcam pour communication video (seulement pour certains modèles).

















#	Icône	Élément	Description
2		Microphone	Microphone interne pour l'enregistrement sonore.
3		Écran d'affichage	Également appelé écran LCD (Liquid Crystal Display), affiche les données de l'ordinateur (seulement pour certains modèles).
4		Indicateur du disque dur	Indique l'activité du disque dur.
		Indicateur Verr Num	Est allumé lorsque Verr Num est activée.
		Indicateur Verr Maj	Est allumé lorsque Verr Maj est activée.
5		Bouton d'alimentation	Met l'ordinateur sous tension et hors tension.
6		Clavier	Pour l'entrée des informations dans votre ordinateur.
7		Touchpad	Périphérique de pointage sensible au touché qui fonctionne comme une souris.
8		Indicateur d'alimentation <sup>1</sup>	Indique l'état d'alimentation de l'ordinateur.
		Indicateur de batterie <sup>1</sup>	Indique l'état de la pile de l'ordinateur. <b>1. Charge :</b> La lumière est orange lorsque la pile se recharge. <b>2. Pleine charge :</b> La diode est bleue en mode secteur.
		Indicateur de communication <sup>1</sup>	Indique l'état du périphérique de connectivité sans fil de l'ordinateur.
9		Boutons (gauche et droit)	Le bouton gauche et le bouton droit fonctionnent comme le bouton gauche et le bouton droit d'une souris.
10		Repose mains	Zone de support confortable pour vos mains lorsque vous utilisez l'ordinateur.
11		Haut-parleurs	Les haut-parleurs de gauche et de droite produisent une sortie audio stéréo.
12		Bouton d'éjection du lecteur optique	Éjecte le disque optique du lecteur.
13		Touche programmable	Programmable par l'utilisateur (seulement pour certains modèles).
		Touche PowerSmart	Place votre ordinateur en mode d'économie d'énergie (seulement pour certains modèles).

1. Les indicateurs du panneau avant sont visibles même lorsque l'écran LCD est fermé.

## Touches spéciales

L'ordinateur emploie des touches spéciales (combinaisons de touches) pour accéder à la plupart des contrôles de l'ordinateur comme la luminosité de l'écran et le volume sonore.

Pour activer les touches spéciales, appuyez et maintenez la touche **<Fn>** avant d'appuyer sur l'autre touche dans la combinaison de la touche spéciale.

Touche spéciale	Icône	Fonction	Description
<Fn> + <F3>		Touche Communication	Active/désactive les périphériques de communication de l'ordinateur (Les périphériques de communication peuvent varier en fonction de la configuration).
<Fn> + <F4>		Sommeil	Place l'ordinateur en mode de Sommeil.
<Fn> + <F5>		Choix de l'affichage	Permet de faire passer l'affichage entre l'écran d'affichage, le moniteur externe (s'il est connecté) et les deux.
<Fn> + <F6>		Affichage éteint	Désactive le rétro éclairage de l'écran pour économiser l'énergie. Appuyez sur une touche pour le rallumer.
<Fn> + <F7>		Touchpad	Active et désactive le touchpad.
<Fn> + <F8>		Haut-parleur	Active et désactive les haut-parleurs.
<Fn> + <D>		Accroissement de la luminosité	Augmente la luminosité de l'écran.
<Fn> + <D>		Décroissement de la luminosité	Diminue la luminosité de l'écran.
<Fn> + <Δ>		Volume +	Augmente le volume sonore.
<Fn> + <∇>		Volume -	Diminue le volume sonore.
<Fn> + <Origine>		Lecture/Pause	Lisez ou effectuez une pause d'un fichier multimédia sélectionné.
<Fn> + <Pg préc.>		Arrêter	Arrêtez la lecture du fichier multimédia sélectionné.
<Fn> + <Pg suiv.>		Précédent	Retournez au fichier multimédia précédent.
<Fn> + <Fin>		Suiv	Passez au fichier multimédia suivant.



## Vue frontale fermée



#	Icône	Élément	Description
1		Lecteur de cartes multiples en un	<p>Accepte une carte mémoire Secure Digital (SD), MultiMediaCard (MMC), Memory Stick (MS), Memory Stick Pro (MS PRO), et xD-Picture (xD).</p> <p><b>Remarque :</b> Poussez pour retirer/installer la carte. Seule une carte peut fonctionner à un moment donné.</p>

## Vue droite



#	Icône	Élément	Description
1		Port USB 2.0	Se connectent à des périphériques USB 2.0 (p.ex. une souris USB, une caméra USB).
2		Lecteur optique	Lecteur optique interne, accepte les CD ou les DVD.
3		Indicateur d'accès du disque optique	S'allume lorsque le lecteur optique est actif.
4		Trou d'éjection d'urgence	<p>Éjecte le plateau du lecteur optique lorsque l'ordinateur est hors tension.</p> <p><b>Remarque :</b> Insérez un trombone dans le trou d'éjection d'urgence pour éjecter le plateau du lecteur optique même quand l'ordinateur est éteint.</p>
5		Prise d'alimentation	Se connecte à l'adaptateur secteur.



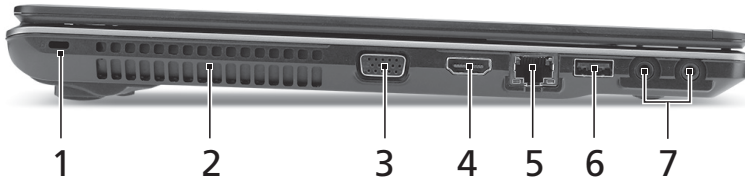

## Vue gauche

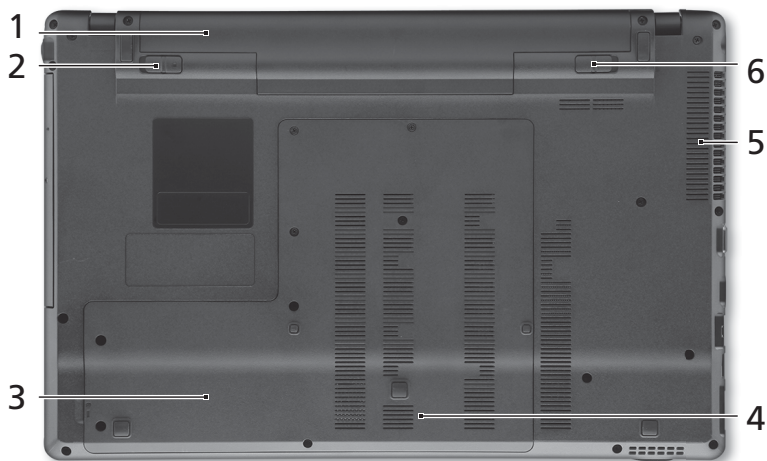

#	Icône	Élément	Description
1		Fente pour cadenas Kensington	Se connecte à un cadenas de sécurité pour ordinateur Kensington.
2		Fentes de ventilation	Permettent à l'ordinateur de rester froid, même après une longue utilisation.
3		Port d'affichage (VGA) externe	Se connecte à un périphérique d'affichage (p.ex. un moniteur externe, un projecteur LCD).
4		Port HDMI	Prend en charge les connexions vidéo numériques à haute définition.
5		Port Ethernet RJ-45	Se connecte à un réseau Ethernet 10/100/1000 Base.
6		Port USB 2.0	Se connectent à des périphériques USB 2.0 (p.ex. une souris USB, une caméra USB).
7		Prise microphone	Accepte les entrées de microphones externes.
		Prise de sortie audio/haut-parleur/casque avec prise en charge de SPDIF	Se connecte à des périphériques audio en sortie (p.ex. haut-parleurs ou un casque stéréo).

## Vue de la base



#	Icône	Élément	Description
1		Baie de la batterie	Contient la batterie de l'ordinateur.
2		Verrou de la batterie	Verrouille la batterie en position.
3		Baie du disque dur	Contient le disque dur de l'ordinateur (fixé avec des vis).
4		Compartiment mémoire	Contient la mémoire principale de l'ordinateur.
5		Fentes de ventilation et ventilateur de refroidissement	Permettent à l'ordinateur de rester froid, même après une longue utilisation. <b>Remarque :</b> Ne couvrez pas et ne bloquez pas l'ouverture du ventilateur.
6		Loquet de libération de la batterie	Libère la batterie pour le retrait.

## Environnement

---

- Température :
    - En marche : 5°C à 35°C
    - À l'arrêt : -20°C à 65°C
  - Humidité (sans condensation) :
    - En marche : 20% à 80%
    - À l'arrêt : 20% à 80%
- 



.....

**Remarque :** Les spécifications ci-dessus sont pour référence seulement. La configuration exacte de votre ordinateur dépend du modèle acheté.

# Aspire 5745/5553 Serie

Kurzanleitung

© 2010 Alle Rechte vorbehalten.

Kurzanleitung für Aspire 5745/5553 Serie  
Originalausgabe: 03/2010

Notebook-PC der Aspire 5745/5553 Serie

Modellnummer: \_\_\_\_\_

Seriennummer: \_\_\_\_\_

Kaufdatum: \_\_\_\_\_

Kaufort: \_\_\_\_\_



# Das Wichtigste zuerst

Wir möchten uns bei Ihnen dafür bedanken, dass Sie sich in Bezug auf mobilen Computerbedarf für ein Acer-Notebook entschieden haben.

## Ihre Anweisungen

Als Hilfe für Sie beim Benutzen Ihres Acer-Notebooks haben wir einen Satz von Richtlinien aufgestellt:

Zuallererst hilft Ihnen das Übersichtsblättchen **Für den Anfang...**, Ihren Computer das erste Mal in Betrieb zu nehmen.

Die **Allgemeine Bedienungsanleitung für die Aspire Serie** enthält hilfreiche Informationen, die sich auf alle Modelle der Aspire-Produktserien beziehen. Es werden Themen wie z. B. die Verwendung der Tastatur, Audio usw. behandelt. Die **Allgemeine Bedienungsanleitung** und die **AcerSystem User Guide** können sich z. T. auf Funktionen oder Eigenschaften beziehen, die es nur in bestimmten Modellen der Serien und nicht unbedingt in dem von Ihnen erworbenen Modell gibt. Solche Stellen sind im Text als "Nur für bestimmte Modelle" gekennzeichnet.

Das **Kurzanleitung** stellt Ihnen die grundlegenden Features und Funktionen Ihres neuen Computers vor. Für weitere Informationen dazu, wie Ihnen Ihr Computer helfen kann, noch produktiver zu arbeiten, lesen Sie bitte den **AcerSystem User Guide**. Dieses Benutzerhandbuch enthält detaillierte Informationen zu Themen wie z. B. System-Programmen, Datenwiederherstellung, Erweiterungsoptionen und Problemlösung. Darüber hinaus enthält es Informationen zur Garantie und allgemeine Bestimmungen und Sicherheitshinweise zu Ihrem Notebook. Das Benutzerhandbuch steht in PDF (Portable Document Format) zur Verfügung und ist bereits in Ihrem Notebook installiert. Folgen Sie den folgenden Schritten, um auf das Benutzerhandbuch zuzugreifen:

- 1 Klicken Sie auf  **Start > Alle Programme > AcerSystem**.
- 2 Klicken Sie auf **AcerSystem User Guide**.



.....

**Hinweis:** Zum Betrachten der Datei muß Adobe Reader installiert sein. Wenn Adobe Reader nicht auf Ihrem Computer installiert ist, wird durch Klicken auf **AcerSystem User Guide** zuerst das Setup-Programm von Adobe Reader ausgeführt. Folgen Sie zum Durchführen der Installation den Anweisungen auf dem Bildschirm. Hinweise über die Verwendung von Adobe Reader finden Sie im Menü **Hilfe und Support**.







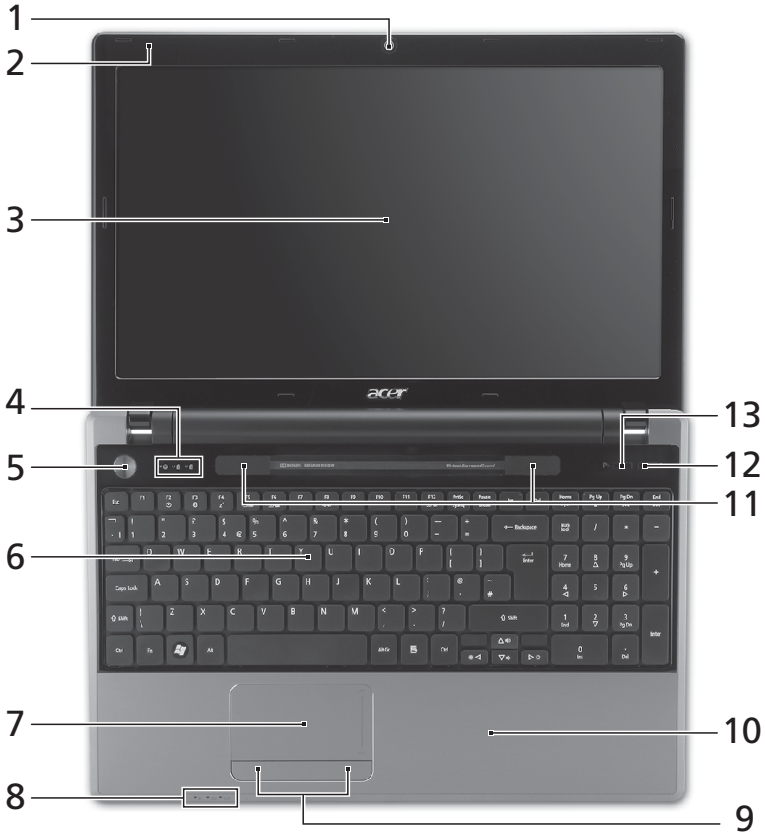

# Ihre Acer-Notebook-Tour

Nachdem Sie den Computer wie im Übersichtsblättchen gezeigt aufgestellt haben, finden Sie im Folgenden eine Übersicht über Ihr neues Acer-Notebook.

## Ansicht von oben



#	Symbol	Element	Beschreibung
1		Acer Crystal Eye Webcam	Web-Kamera für Videokommunikation (Nur für bestimmte Modelle).
2		Mikrofon	Internes Mikrofon für Tonaufnahme.











#	Symbol	Element	Beschreibung
3		Anzeigebildschirm	Wird auch als LCD (Liquid-Crystal-Display) bezeichnet. Zeigt die Ausgabe des Computers an (Konfiguration kann sich von Modell zu Modell unterscheiden).
4		HDD Anzeige	Leuchtet auf, wenn die Festplatte aktiv ist.
		Num Lock-Anzeige	Leuchtet auf, wenn die Num Lock-Funktion aktiviert ist.
		Caps Lock-Anzeige	Leuchtet auf, wenn die Caps Lock-Funktion aktiviert ist.
5		Ein/Aus-Taste	Schaltet den Computer ein und aus.
6		Tastatur	Dient der Eingabe von Daten in den Computer.
7		Touchpad	Berührungssensibles Zeigegerät, das die gleichen Funktionen besitzt wie eine Computer-Maus.
8		Energieanzeige <sup>1</sup>	Zeigt den Ein/Aus-Status des Computers an.
		Akku-Anzeige <sup>1</sup>	Zeigt den Akkustatus des Computers an. <b>1. Aufladung:</b> Die Leuchte erscheint gelb, wenn der Akku aufgeladen wird. <b>2. Voll aufgeladen:</b> Die Leuchte erscheint blau, wenn Netzstrom verwendet wird.
		Anzeige für Kommunikation <sup>1</sup>	Zeigt den Drahtlos-Konnektivitätsstatus des Computers an.
9		Anklicktasten (links und rechts)	Die linken und rechten Tasten funktionieren wie die linken und rechten Tasten einer Maus.
10		Handablage	Bequemer Ablagebereich für Ihre Hände während der Bedienung des Computers.
11		Lautsprecher	Linker und rechter Lautsprecher bieten Audioausgabe in Stereo.
12		Auswurfaste für optisches Laufwerk	Fährt das optische Laufwerk heraus.
13	<b>P</b>	Programmierbare Taste	Durch Benutzer programmierbar (Nur für bestimmte Modelle).
		PowerSmart Taste	Aktiviert den Energiesparmodus des Computers (Nur für bestimmte Modelle).

1. Die Statusanzeigen auf der Vorderseite sind selbst dann zu sehen, wenn die Computerklappe geschlossen ist.

## Tastenkombinationen

Der Computer besitzt Direkttasten oder Tastenkombinationen für den Zugriff auf Computersteuerungen wie z. B. Bildschirmhelligkeit und Ausgangslautstärke.

Zum Aktivieren von Hotkeys müssen Sie zuerst die **<Fn>** Taste drücken und halten und dann die andere Taste der Tastenkombination-Kombination drücken.

Tastenkombination	Symbol	Funktion	Beschreibung
<Fn> + <F3>		Kommunikationstaste	Aktiviert/deaktiviert die Kommunikationseinrichtungen des Computers (Kommunikationseinrichtungen können je nach Konfiguration abweichen).
<Fn> + <F4>		Schlaf	Schaltet den Computer in den Schlaf-Modus.
<Fn> + <F5>		Display-Umschalter	Wechselt die Anzeigerausgabe zwischen Anzeigebildschirm, externem Monitor (falls angeschlossen) und gleichzeitig beiden Anzeigen.
<Fn> + <F6>		Display AUS	Schaltet die Hintergrundbeleuchtung des Bildschirms aus, um Energie zu sparen. Drücken Sie zum Einschalten eine beliebige Taste.
<Fn> + <F7>		Touchpad-Schalter	Schaltet das interne Touchpad ein oder aus.
<Fn> + <F8>		Lautsprecherschalter	Schaltet die Lautsprecher ein und aus.
<Fn> + <▷>		Heller	Erhöht die Bildschirmhelligkeit.
<Fn> + <◁>		Dunkler	Verringert die Bildschirmhelligkeit.
<Fn> + <△>		Lauter	Erhöht die Lautstärke.
<Fn> + <▽>		Leiser	Verringert die Lautstärke.

Tastenkombination	Symbol	Funktion	Beschreibung
<Fn> + <Home>	▶/	Wiedergabe/ Pause	Spielt oder pausiert eine gewählte Mediendatei.
<Fn> + <Nachoben-Pfeil>	■	Stopp	Hält die gewählte Mediendatei an.
<Fn> + <Nachunten-Pfeil>	◀◀	Zurück	Zurück zur vorherigen Mediendatei.
<Fn> + <Ende>	▶▶	Weiter	Springt zur nächsten Mediendatei.



## Geschlossene Vorderseite



#	Symbol	Element	Beschreibung
1		Mehrere-in-1-Kartenleser	Eignet sich für Secure Digital (SD), MultiMediaCard (MMC), Memory Stick (MS), Memory Stick PRO (MS PRO) und xD-Picture Card (xD). <b>Hinweis:</b> Drücken Sie hier, um die Karte zu entfernen/einzusetzen. Es kann nicht mehr als eine Karte gleichzeitig verwendet werden.

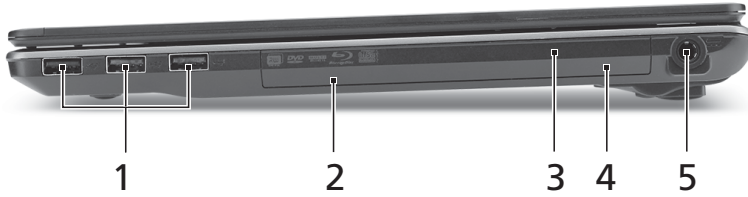





## Rechte Seite

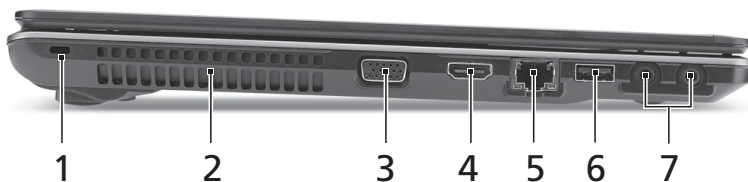

#	Symbol	Element	Beschreibung
1		USB 2.0-Anschluss	Dient dem Anschluss von USB 2.0-Geräten (z.B. USB-Maus, USB-Kamera).
2		Optisches Laufwerk	Internes optisches Laufwerk; eignet sich für CDs oder DVDs.
3		Optische Disk Anzeige	Leuchtet auf, wenn optisches Laufwerk aktiv ist.
4		Mechanisches Auswurfloch	Schiebt den Träger des optischen Laufwerks aus, wenn der Computer ausgeschaltet ist. <b>Hinweis:</b> Stecken Sie eine Büroklammer in das Auswurfloch, um den Träger des optischen Laufwerkes herauszufahren, wenn der Computer nicht eingeschaltet ist.
5		DC-Eingangsbuchse	Hier schließen Sie das Netzteil an.





## Linke Seite

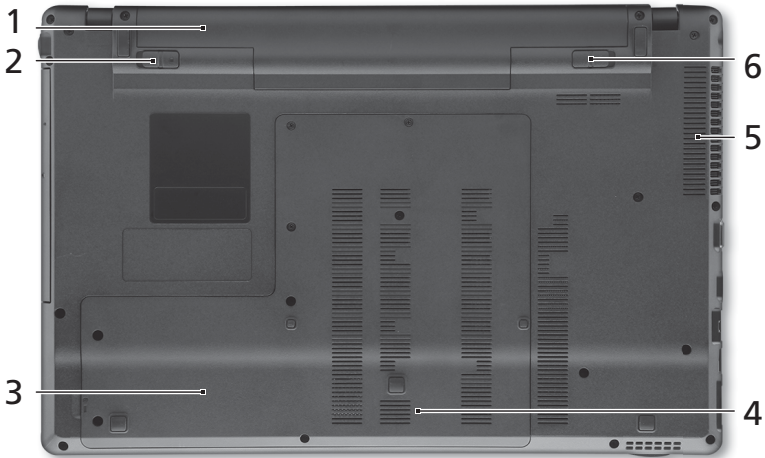

#	Symbol	Element	Beschreibung
1		Steckplatz für Kensington-Schloss	Hier können Sie ein Kensington-kompatibles Sicherheitsschloss für den Computer anbringen.
2		Belüftungsschlitze	Schützt den Computer vor Überhitzung, selbst bei längerem Einsatz.
3		Anschluss für externe Anzeige (VGA)	Zum Anschluss eines Anzeigegeräts (z.B. externer Monitor, LCD-Projektor).
4		HDMI-Anschluss	Unterstützt digitale High-Definition-Video-Verbindungen.
5		Ethernet (RJ-45)-Anschluss	Zum Anschluss eines Ethernet 10/100/1000-basierten Netzwerks.
6		USB 2.0-Anschluss	Dient dem Anschluss von USB 2.0-Geräten (z.B. USB-Maus, USB-Kamera).
7		Mikrofonbuchse	Eignet sich für Eingaben aus externen Mikrofonen.
		Buchse für Kopfhörer/Lautsprecher/Ausgang mit S/PDIF-Unterstützung	Zum Anschluss von Audioausgabe-Geräten (z.B. Lautsprechern, Kopfhörern).

## Unterseite



#	Symbol	Element	Beschreibung
1		Akkufach	Enthält den Akku des Computers.
2		Akkuverschluss	Sichert den Akku an seiner Position.
3		Festplattenfach	Enthält die Computer-Festplatte (durch Schrauben gesichert).
4		Speicherfach	Enthält den Hauptspeicher des Computers.
5		Belüftungsschlitze und Ventilator	Schützt den Computer vor Überhitzung, selbst bei längerem Einsatz. <b>Hinweis:</b> Verdecken oder schließen Sie nicht die Öffnungen des Ventilators.
6		Verriegelung des Akkus	Entsperrt den Akku für die Herausnahme.



## Umgebung

---

- Temperatur:
    - Betrieb: 5°C bis 35°C
    - Nichtbetrieb: -20°C bis 65°C
  - Luftfeuchtigkeit (nicht kondensierend):
    - Betrieb: 20% bis 80%
    - Nichtbetrieb: 20% bis 80%
- 



.....

**Hinweis:** Die oben angeführten Daten dienen lediglich als Anhaltspunkt. Die genaue Konfiguration des PCs hängt von dem Modell ab, das Sie kaufen.



# Serie Aspire 5745/5553

Guida rapida

© 2010 Tutti i diritti riservati.

Guida rapida Serie Aspire 5745/5553

Prima edizione: 03/2010

PC Notebook Serie Aspire 5745/5553

Numero di modello: \_\_\_\_\_

Numero di serie: \_\_\_\_\_

Data di acquisto: \_\_\_\_\_

Luogo d'acquisto: \_\_\_\_\_

# Avvertenze preliminari

Grazie per aver scelto il notebook Acer, la scelta ideale per poter lavorare in piena libertà anche in movimento.

## Le guide disponibili

Sono state realizzate delle guide per assistere l'utente nell'uso del notebook Acer:

Innanzitutto, il documento **Per i principianti...** per semplificare la configurazione del computer.

La **Manale utente generale a Aspire Series** contiene informazioni utili per tutti i modelli della serie Aspire. Copre gli argomenti base come ad esempio l'uso della tastiera, audio, ecc. A causa della sua natura, la **Manale utente generale** così come il **AcerSystem User Guide** menzionata in precedenza a volte fa riferimento a funzioni o caratteristiche presenti solamente in alcuni modelli della serie, ma non necessariamente del modello acquistato. Per questo motivo alcuni elementi nel testo sono indicati con "solo per alcuni modelli".

**Guida rapida** vi presenta le caratteristiche e le funzioni principali del vostro nuovo computer. Per altre nozioni su come il vostro computer può aiutarvi a diventare ancora più produttivi, consultate la **AcerSystem User Guide**. Questa guida contiene informazioni dettagliate su argomenti come utilità del sistema, ripristino dei dati, opzioni di espansione e ricerca guasti. In aggiunta contiene le informazioni sulla garanzia e i regolamenti generali e le avvertenze per la sicurezza del vostro notebook. È disponibile nel formato PDF (Portable Document Format) e viene fornita già caricata nel notebook. Per accedervi seguite questi passaggi:

- 1 Fare clic su  **Start > Programmi > AcerSystem**.
- 2 Fare clic su **AcerSystem User Guide**.



.....

**Nota:** Per visualizzare il file, è necessario che sul computer sia installato Adobe Reader. Se Adobe Acrobat Reader non è installato sul computer, fare clic su **AcerSystem User Guide** per eseguire il programma di installazione di Adobe Reader. Per completare l'installazione, attenersi alle istruzioni visualizzate sullo schermo. Per istruzioni sull'uso di Adobe Reader, consultare il menu **Guida in linea e supporto tecnico**.







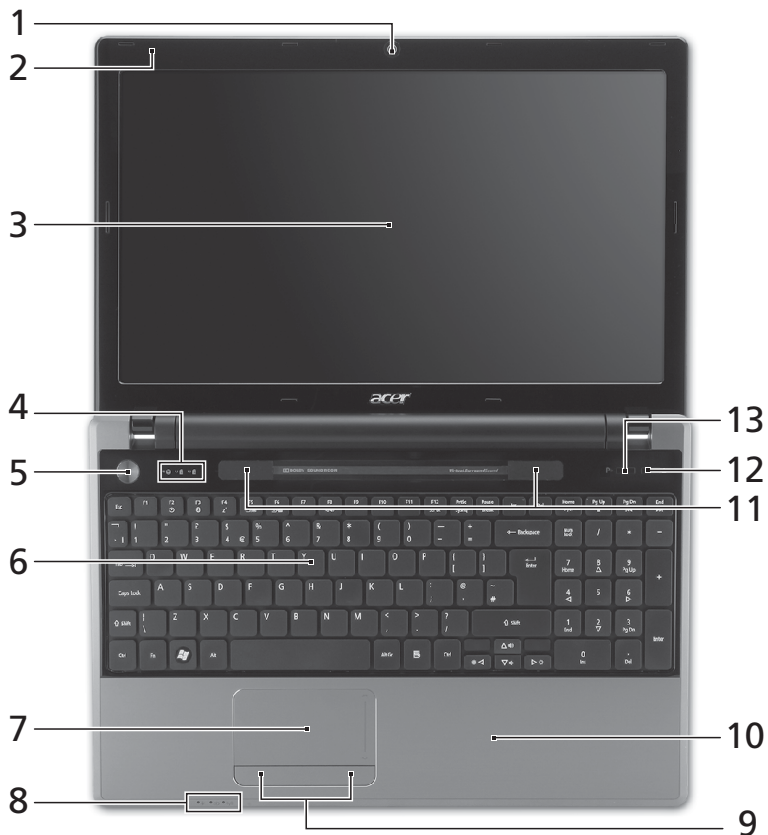

# Presentazione del notebook Acer

Dopo aver configurato il computer come illustrato nel manifesto, far riferimento alla presente documentazione per la presentazione del nuovo notebook Acer.

## Vista dall'alto



#	Icona	Elemento	Descrizione
1		Webcam Acer Crystal Eye	Web camera per la comunicazione video (solo per alcuni modelli).

#	Icona	Elemento	Descrizione
2		Microfono	Microfono interno per la registrazione di audio.
3		Display	Grande display a cristalli liquidi (Liquid-Crystal Display; LCD), per una visualizzazione confortevole (la configurazione può variare in relazione al modello).
4		Indicatore disco rigido	Si accende quando l'hard disk è attivo.
		Indicatore Bloc Num	Si illumina quando Bloc Num è attivato.
		Indicatore Bloc Maiusc	Si illumina quando Bloc Maiusc è attivato.
5		Tasto di accensione	Accende/spegne il computer.
6		Tastiera	Per l'immissione di dati sul computer.
7		Touchpad	Dispositivo di puntamento sensibile al tocco con funzioni simili a quelle di un comune mouse.
8		Indicatore di accensione/alimentazione <sup>1</sup>	Indicano lo stato di accensione/alimentazione del computer.
		Indicatore batteria <sup>1</sup>	Indicano lo stato della batteria del computer. <b>1. In carica:</b> Luce di colore giallo quando la batteria è in ricarica. <b>2. Completamente carica:</b> Luce di colore blu quando è nella modalità AC.
		Indicatore comunicazione <sup>1</sup>	Indica lo stato della connettività wireless del computer.
9		Tasti clic (sinistra e destra)	I tasti destra e sinistra hanno le stesse funzioni dei tasti destra e sinistra del mouse.
10		Poggiapolsi	Comoda area su cui poggiare i polsi durante l'utilizzo del computer.
11		Altoparlanti	Altoparlante sinistro e destro per la diffusione di audio in uscita.
12		Tasto di espulsione del disco ottico	Espelle il disco ottico dall'unità.







#	Icona	Elemento	Descrizione
13	P	Tasto programmabile	Programmabile dall'utente (solo per alcuni modelli).
		Tasto PowerSmart	Per attivare la modalità di risparmio energetico (solo per alcuni modelli).

1. Gli indicatori del pannello frontale sono visibili anche quando il coperchio del computer è chiuso.







## Tasti di scelta rapida

Il computer utilizza i tasti di scelta o le combinazioni di tasti per l'accesso a molti controlli del computer come luminosità dello schermo e uscita volume.

Per attivare i tasti di scelta rapida, tenere premuto <Fn> e premere l'altro tasto della combinazione.

Tasti di scelta rapida	Icona	Funzione	Descrizione
<Fn> + <F3>		Tasto comunicazioni	Attiva/disattiva i dispositivi di comunicazione del computer (i dispositivi di comunicazione possono variare in relazione alla configurazione).
<Fn> + <F4>		Sospensione	Attiva la modalità sospensione del computer.
<Fn> + <F5>		Passaggio da uno schermo all'altro	Consente la commutazione in uscita display tra video del display o monitor esterno (se collegato) e entrambi.
<Fn> + <F6>		Disattiva display	Disattiva la retroilluminazione dello schermo per risparmiare energia. Premere un tasto qualsiasi per tornare allo stato precedente.
<Fn> + <F7>		Attivazione e disattivazione del touchpad	Attiva e disattiva il touchpad interno.
<Fn> + <F8>		Attivazione e disattivazione degli altoparlanti	Attiva e disattiva gli altoparlanti.
<Fn> + <D>		Aumento della luminosità	Consente di aumentare la luminosità dello schermo.



Tasti di scelta rapida	Icona	Funzione	Descrizione
<Fn> + <◀▶>		Riduzione della luminosità	Riduce la luminosità dello schermo.
<Fn> + <▲>		Aumento del volume	Aumenta il volume.
<Fn> + <▼>		Riduzione del volume	Riduce il volume.
<Fn> + <Home>		Play/Pausa	Riproduce o sospende la riproduzione del file multimediale selezionato.
<Fn> + <Pag su>		Interrompi	Interrompe la riproduzione del file multimediale selezionato.
<Fn> + <Pag giù>		Precedente	Per passare al file multimediale precedente.
<Fn> + <Fine>		Successivo	Per passare al file multimediale successivo.



## Vista frontale in dettaglio



#	Icona	Elemento	Descrizione
1		Letto di schede multiplo	Supporta Secure Digital (SD), MultiMediaCard (MMC), Memory Stick (MS), Memory Stick Pro (MS PRO), e xD-Picture Card (xD). <b>Nota:</b> Premere per rimuovere/installare la scheda. È possibile utilizzare una sola scheda di memoria alla volta.







## Vista da destra

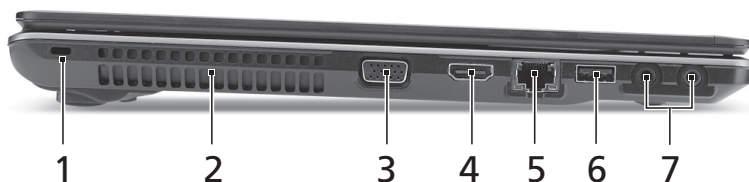

#	Icona	Elemento	Descrizione
1		Porta USB 2.0	Effettua il collegamento ai dispositivi USB 2.0 (ad es., mouse USB, fotocamera USB).
2		Lettore ottico	Unità ottica interna, accetta CD o DVD.
3		Indicatore accesso disco ottico	Si accende quando il disco ottico è attivo.
4		Foro di espulsione di emergenza	Espelle il vassoio del disco ottico se il computer è spento. <b>Nota:</b> Inserire la punta di un fermaglio nel foro di apertura di emergenza per espellere il vassoio dell'unità ottica quando il computer è spento.
5		Jack CC-in	Per il collegamento all'adattatore CA.





## Vista da sinistra

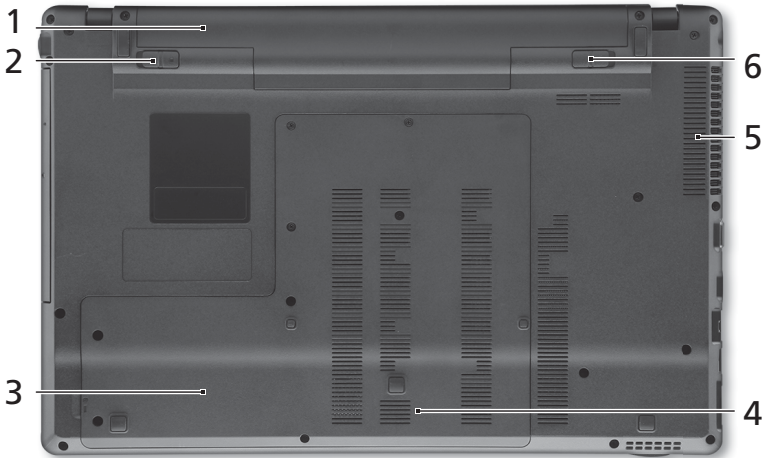

#	Icona	Elemento	Descrizione
1		Slot blocco Kensington	Per il collegamento al blocco di sicurezza dei computer Kensington-compatibili.
2		Aperture per la ventilazione	Permettono il raffreddamento del computer, anche dopo un uso prolungato.
3		Porta display esterno (VGA)	Effettua il collegamento a un dispositivo di visualizzazione (ad es., monitor esterno, proiettore LCD).
4		Porta HDMI	Supporta collegamento per video digitali ad alta definizione.
5		Porta Ethernet (RJ-45)	Effettua il collegamento a una rete con Ethernet 10/100/1000.
6		Porta USB 2.0	Effettua il collegamento ai dispositivi USB 2.0 (ad es., mouse USB, fotocamera USB).
7		Jack microfono	Accetta ingressi proveniente da microfoni esterni.
		Jack auricolari/ altoparlante/ line-out con supporto S/PDIF	Effettua il collegamento ai dispositivi audio line-out (ad es., altoparlanti, auricolari).

## Vista base



#	Icona	Elemento	Descrizione
1		Alloggiamento della batteria	Contiene il pacco batteria del computer.
2		Blocco batteria	Blocca la batteria al suo posto.
3		Alloggiamento per il disco rigido	Alloggia il disco rigido del computer (fissato con viti).
4		Vano per la memoria	Contiene la memoria principale del computer.
5		Aperture per la ventilazione e ventola di raffreddamento	Permettono il raffreddamento del computer, anche dopo un uso prolungato. <b>Nota:</b> Non coprire e non ostruire l'apertura della ventola.
6		Gancio di rilascio della batteria	Per togliere la batteria.

## Condizioni operative

---

- Temperatura:
    - Di esercizio: da 5°C a 35°C
    - Non di esercizio: da -20°C a 65°C
  - Umidità (senza condensa):
    - Di esercizio: da 20% a 80%
    - Non di esercizio: da 20% a 80%
- 



.....

**Nota:** Le specifiche tecniche sono solo di riferimento.  
La configurazione esatta del PC dipende dal modello acquistato.



# Serie Aspire 5745/5553

Guía rápida

© 2010 Reservados todos los derechos.

Guía rápida de la Serie Aspire 5745/5553  
Versión original: 03/2010

Ordenador portátil Serie Aspire 5745/5553

Número de modelo: \_\_\_\_\_

Número de serie: \_\_\_\_\_

Fecha de compra: \_\_\_\_\_

Lugar de compra: \_\_\_\_\_



# Primero lo más importante

Le agradecemos que haya elegido el ordenador portátil Acer para satisfacer sus necesidades de informática móvil.

## Las guías

Para ayudarle a utilizar el ordenador portátil Acer, hemos elaborado un conjunto de guías:

En primer lugar, el póster **Para principiantes...** contiene información de ayuda para configurar el ordenador.

La **Guía genérica del usuario de la serie Aspire** contiene información útil aplicable a todos los modelos de productos de la serie Aspire. Contempla aspectos básicos como el uso del teclado, el audio, etc. No obstante, no se olvide que debido a su carácter, la **Guía genérica del usuario** además de la **AcerSystem User Guide** mencionada a continuación se referirá ocasionalmente a las funciones o características incluidas sólo en ciertos modelos de la serie, pero no necesariamente al modelo que haya adquirido usted. Dichos ejemplos se marcará en el texto con indicaciones como "sólo en ciertos modelos".

La **Guía rápida** presenta las características y funciones básicas de su nuevo ordenador. Para obtener más información sobre cómo el ordenador puede ayudarle a ser más productivo, consulte la **AcerSystem User Guide**. Esa guía contiene información detallada sobre temas como utilidades del sistema, recuperación de datos, opciones de expansión y resolución de problemas. También contiene información sobre la garantía, así como reglamentos generales y avisos de seguridad para el ordenador portátil. Está disponible en formato PDF (Portable Document Format) y viene instalada en el ordenador portátil. Siga el procedimiento siguiente para acceder a la misma:

- 1 Haga clic en  **Inicio > Todos los programas > AcerSystem.**
- 2 Haga clic en **AcerSystem User Guide.**



-----

**Nota:** Para poder ver el archivo, debe tener instalado Adobe Reader. Si no lo tiene instalado, haga clic en **AcerSystem User Guide** para que se ejecute el programa de instalación de Adobe Reader. Siga las instrucciones en pantalla para completar la instalación. Para obtener información sobre cómo utilizar Adobe Reader, acceda al menú **Ayuda y soporte técnico.**







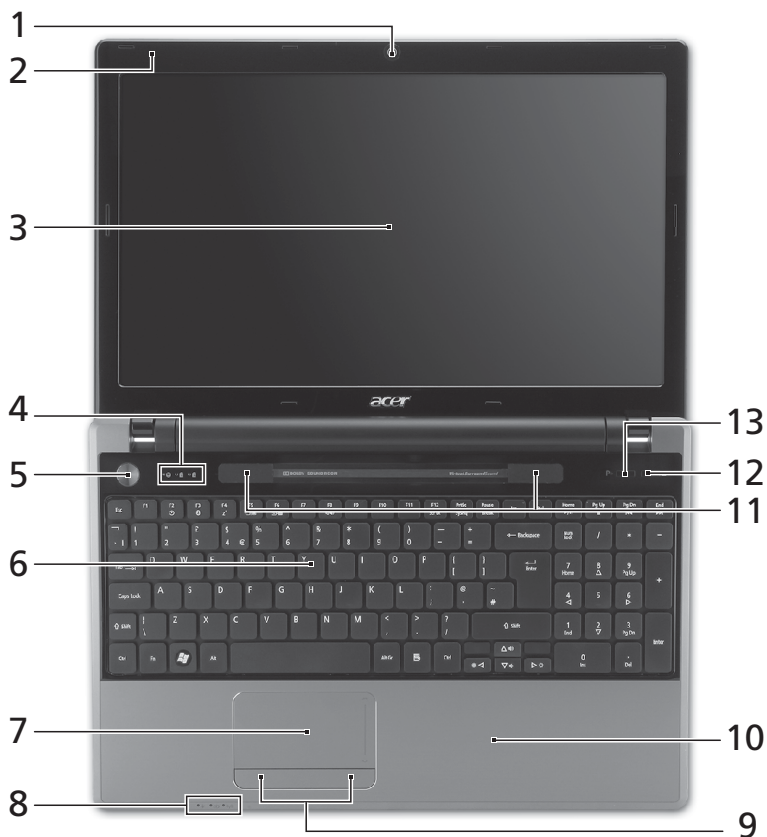

# Un paseo por el ordenador portátil Acer

Una vez configurado el ordenador del modo indicado en el póster, iniciaremos un paseo por su nuevo portátil Acer.

## Vista superior



#	Icono	Elemento	Descripción
1		Webcam Acer Crystal Eye	Cámara Web para comunicación de vídeo (sólo en ciertos modelos).
2		Micrófono	Micrófono interno para la grabación de sonido.

#	Icono	Elemento	Descripción
3		Visualización en pantalla	También denominada pantalla de cristal líquido (LCD) es el dispositivo de salida visual del ordenador (la configuración puede variar según el modelo).
4		Indicador de disco duro	Indica si la unidad de disco duro está activa.
		Indicador de Bloq Núm	Se enciende al activar el bloqueo del teclado numérico.
		Indicador de Bloq Mayús	Se enciende al activar el bloqueo de mayúsculas.
5		Botón de encendido	Enciende o apaga el ordenador.
6		Teclado	Para introducir datos en su ordenador.
7		Teclado táctil	Dispositivo apuntador táctil que funciona como un ratón de ordenador.
8		Indicador de encendido <sup>1</sup>	Proporciona información sobre el estado de energía del ordenador.
		Indicador de batería <sup>1</sup>	Proporciona información sobre el estado de la batería. <b>1. Carga:</b> La luz se vuelve ámbar cuando se carga de la batería. <b>2. Carga completa:</b> La luz se vuelve azul en modo de CA.
		Indicador de comunicación <sup>1</sup>	Proporciona información sobre el estado del dispositivo de conectividad inalámbrica.
9		Botones de clic (izquierdo y derecho)	Los botones izquierdo y derecho funcionan como los botones izquierdo y derecho del ratón.
10		Soporte para las palmas	Área de soporte que permite reposar cómodamente las palmas de las manos cuando se utiliza el ordenador.
11		Altavoces	Los altavoces izquierdo y derecho proporcionan una salida de audio.
12		Botón de expulsión de la unidad óptica	Expulsa el disco óptico de la unidad.
13	<b>P</b>	Tecla programable	Programable por el usuario (sólo en ciertos modelos).
		Tecla PowerSmart	Activa el modo de ahorro de energía del ordenador (sólo en ciertos modelos).

1. Los indicadores del panel frontal son visibles aunque se cierre la tapa del ordenador.

## Teclas de acceso directo

El ordenador utiliza teclas de acceso directo o combinaciones de teclas para acceder a la mayoría de controles del ordenador como el brillo de la pantalla o la salida de volumen.

Para activar las teclas de acceso directo, mantenga pulsada la tecla **<Fn>** y pulse la siguiente tecla de la combinación.

Tecla de acceso directo	Icono	Función	Descripción
<b>&lt;Fn&gt; + &lt;F3&gt;</b>		Tecla de comunicación	Activa/desactiva los dispositivos de comunicación del ordenador (Los dispositivos de comunicación pueden variar según la configuración).
<b>&lt;Fn&gt; + &lt;F4&gt;</b>		Suspensión	Pone el ordenador en modo de suspensión.
<b>&lt;Fn&gt; + &lt;F5&gt;</b>		Selector de pantalla	Cambia la salida entre la pantalla y el monitor externo (si está conectado) o ambos.
<b>&lt;Fn&gt; + &lt;F6&gt;</b>		Apagado de pantalla	Apaga la luz de fondo de la pantalla para ahorrar energía. Pulse cualquier tecla para encenderla.
<b>&lt;Fn&gt; + &lt;F7&gt;</b>		Panel táctil	Activa o desactiva el panel táctil interno.
<b>&lt;Fn&gt; + &lt;F8&gt;</b>		Alternar altavoces	Activa o desactiva los altavoces.
<b>&lt;Fn&gt; + &lt;▷&gt;</b>		Aumentar brillo	Aumenta el brillo de la pantalla.
<b>&lt;Fn&gt; + &lt;◁&gt;</b>		Disminuir brillo	Disminuye el brillo de la pantalla.
<b>&lt;Fn&gt; + &lt;△&gt;</b>		Subir volumen	Sube el volumen.
<b>&lt;Fn&gt; + &lt;▽&gt;</b>		Bajar volumen	Baja el volumen.
<b>&lt;Fn&gt; + &lt;Inicio&gt;</b>		Reproducir/ Pausa	Reproduce o hace una pausa en un archivo multimedia seleccionado.
<b>&lt;Fn&gt; + &lt;Re Pág&gt;</b>		Detener	Detiene la reproducción del archivo multimedia seleccionado.
<b>&lt;Fn&gt; + &lt;Av Pág&gt;</b>		Anterior	Regresa al archivo multimedia anterior.
<b>&lt;Fn&gt; + &lt;Fin&gt;</b>		Siguiente	Salta al siguiente archivo multimedia.

## Primer plano de la vista frontal



#	Icono	Elemento	Descripción
1		Lector de tarjetas multifunción	Admite la tarjeta Secure Digital (SD), MultiMedia (MMC), Memory Stick (MS), Memory Stick PRO (MS PRO), xD-Picture (xD). <b>Nota:</b> Presionar para extraer/installar la tarjeta. Sólo puede funcionar una tarjeta en un momento dado.

## Vista derecha



#	Icono	Elemento	Descripción
1		Puerto USB 2.0	Conexión para dispositivos USB 2.0 (p.ej., ratón USB o cámara USB).
2		Unidad óptica	Dispositivo óptico interno; acepta CDs y DVDs.
3		Indicador de acceso del disco óptico	Se enciende cuando la unidad óptica está activa.
4		Orificio de expulsión de emergencia	Expulsa la bandeja de la unidad óptica cuando el ordenador está apagado. <b>Nota:</b> Introduzca un clip sujetapapeles en el orificio de expulsión para expulsar la bandeja de la unidad óptica cuando el ordenador esté apagado.
5		Conector de entrada de DC	Permite conectar a un adaptador de CA.



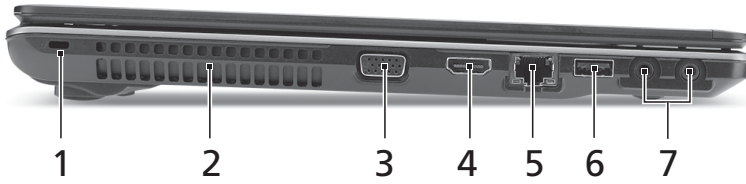

## Vista izquierda

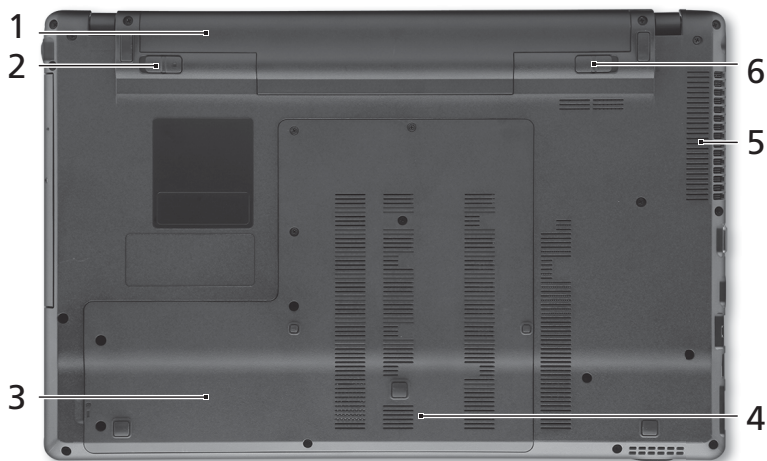

#	Icono	Elemento	Descripción
1		Ranura de bloqueo Kensington	Permite conectar a un candado de seguridad para ordenador compatible con Kensington.
2		Ranuras de ventilación	Permite que el ordenador esté frío, incluso tras un uso prolongado.
3		Puerto de visualización externo (VGA)	Conexión para pantallas (p.ej., monitor externo o proyector LCD).
4		Puerto HDMI	Compatible con conexiones de vídeo digital de alta definición.
5		Puerto Ethernet (RJ-45)	Conexión para una red basada en Ethernet 10/100/1000.
6		Puerto USB 2.0	Conexión para dispositivos USB 2.0 (p.ej., ratón USB o cámara USB).
7		Conector del micrófono	Permite la entrada de audio de micrófonos externos.
		Conector de salida/auriculares/altavoz compatible con S/PDIF	Conexión para dispositivos de salida de audio (p.ej., altavoces, auriculares, etc.).

## Vista de la base



#	Icono	Elemento	Descripción
1		Compartimento de la batería	Aloja la batería del ordenador.
2		Bloqueo de la batería	Permite que la batería quede trabada.
3		Compartimento del disco duro	Contiene el disco duro del ordenador (fijado con tornillos).
4		Compartimento de memoria	Contiene la memoria principal de ordenador.
5		Ranuras de ventilación y ventilador de refrigeración	Permite que el ordenador esté frío, incluso tras un uso prolongado. <b>Nota:</b> No tape ni obstruya la apertura del ventilador.
6		Pestillo de liberación de la batería	Libera la batería para poder sacarla.

## Medio ambiente

---

- Temperatura:
    - Encendido: entre 5°C y 35°C
    - Apagado: entre -20°C y 65°C
  - Humedad (sin condensación):
    - Encendido: entre 20% y 80%
    - Apagado: entre 20% y 80%
- 



.....

**Nota:** Las especificaciones descritas sólo se proporcionan a modo de referencia. La configuración exacta de su PC depende del modelo adquirido.



## Notificacion Regulatoria Adicional

### [Argentina]

El portatil Acer viene con los modulos de telecomunicaciones aprobados ya incorporados para su conexion a la red. El numero de modelo y numero de homologacion especifico para estos modelos se refieren a continuacion.

#### [Modem]

Modelo: RD02-D330	CNC 54-4512
Modelo: Delphi_D40	CNC 53-4581
Modelo: Delphi_D40 (AM5)	CNC 54-5681

#### [Bluetooth]

Modelo: BCM92045NMD	CNC 16-4062
---------------------	-------------

#### [802.11AGN]

Modelo: 4965AGN	CNC C-5421
Modelo: BCM94321MC	CNC C-5225
Modelo: 512AN_MMW	CNC C-6399
Modelo: 533AN_MMW	CNC C-6385

#### [802.11ABG]

Modelo: 4965AG_	CNC C-5424
Modelo: WM3945ABG	CNC C-4531
Modelo: AR5BXB6	CNC C-4340





#### [802.11BG]

Modelo: BCM94311MCG	CNC C-4250
Modelo: AR5BXB63	CNC C-5448
Modelo: BCM94312MCG	CNC C-5871



### [Brasil] Noticia adicional de regulamento Anatel

Os componentes de telecomunicacao usados nos notebooks Acer em Portugues sao homologados atendendo a requisicao da Agencia Nacional de Telecomunicacoes Anatel, conforme referencia abaixo:

#### [Modem]

Modelo: RD02-D330	 1406-05-1675	
Modelo: Delphi_D40	 0455-06-2565	 (01) 0789 834989 0382



#### [Bluetooth]

Modelo: BCM92045NMD	 0578-05-1869	 0107898349891648
------------------------	--	---



## [802.11AGN]

Modelo: 4965AGN	 ANATEL 0578-07-2198	 (01)0789 8355950322
Modelo: BCM94321MC	 ANATEL 1761-06-1869	 0107898349931945
Modelo: 512AN_MMW	 ANATEL 0807-08-2198	 (01) 07898355950018
Modelo: 512AN_HMW	 ANATEL 0800-08-2198	 (01) 07898355950025
Modelo: 533AN_MMW	 ANATEL 0809-08-2198	 (01) 07898355950032
Modelo: 533AN_HMW	 ANATEL 0812-08-2198	 (01) 07898355950049







## [802.11BGN]

Modelo: AR5B91	 ANATEL 1182-08-3987	 7898915959 50 5
-------------------	--	--

## [802.11ABG]

Modelo: 4965AG_	 ANATEL 0350-07-2198	 (01)07898355950339
Modelo: WM3945ABG	 ANATEL 0151-06-2198	 0107898355950063
Modelo: AR5XB6	 ANATEL 1188-05-2634	 0107898914152020

## [802.11BG]

Modelo: BCM94311MCG	 ANATEL 0979-05-1869	 0107898349891747
Modelo: AR5XB63	 ANATEL 1188-05-2634	 0107898915959123
Modelo: BCM94312MCG	 ANATEL 1558-07-1869	 (01)07898349892140

# Série Aspire 5745/5553

Guia rápido

© 2010 Todos os Direitos Reservados.

Guia rápido da Série Aspire 5745/5553

Edição Original: 03/2010

Computador Portátil Série Aspire 5745/5553

Número de Modelo: \_\_\_\_\_

Número de Série: \_\_\_\_\_

Data de Compra: \_\_\_\_\_

Local de Aquisição: \_\_\_\_\_

# Comecemos pelo princípio

Gostaríamos de lhe agradecer por ter escolhido um computador portátil Acer para preencher as suas necessidades de computador móvel.

## Os seus manuais

Para o ajudar a usar o seu computador portátil Acer, preparámos uma série de manuais:

Antes de mais, o cartaz **Para principiantes...** ajuda-o a iniciar e a configurar o seu computador.

O **Manual Genérico do utilizador da Série Aspire** contém informações úteis que se aplicam a todos os modelos da série de produtos Aspire. Abrange tópicos básicos como utilização do teclado, áudio, etc. Pedimos a sua compreensão para o facto de, pela sua natureza, o **Manual Genérico do utilizador** e o **AcerSystem User Guide** abaixo mencionados referem-se ocasionalmente a funções ou funcionalidades apenas aplicáveis a determinados modelos da série, mas não necessariamente ao modelo específico que adquiriu. Estas situações aparecem marcadas no texto com referências como "apenas para determinados modelos".

O **Guia rápido** apresenta as características e funções básicas do seu novo computador. Para mais detalhes sobre como o seu computador o pode ajudar a ser mais produtivo, consulte o **AcerSystem User Guide**. Esse manual contém informações pormenorizadas sobre temas como utilitários do sistema, recuperação de dados, opções de expansão e solução de problemas. Além disso, contém a informação da garantia e as regulamentações gerais e notas de segurança para o seu computador portátil. Está disponível no formato PDF (Portable Document Format) e vem já instalado no seu computador. Siga estes passos para o aceder:

- 1 Clique em  **Iniciar > Todos os programas > AcerSystem**.
- 2 Clique em **AcerSystem User Guide**.



.....

**Nota:** É necessário instalar o Adobe Reader para visualizar o ficheiro. Se o Adobe Reader não estiver instalado no seu computador, ao clicar em **AcerSystem User Guide** é executado o programa de instalação do Acrobat Reader. Siga as instruções do ecrã para finalizar a instalação. Para obter instruções sobre como utilizar o Adobe Reader, vá ao menu **Ajuda e Suporte**.







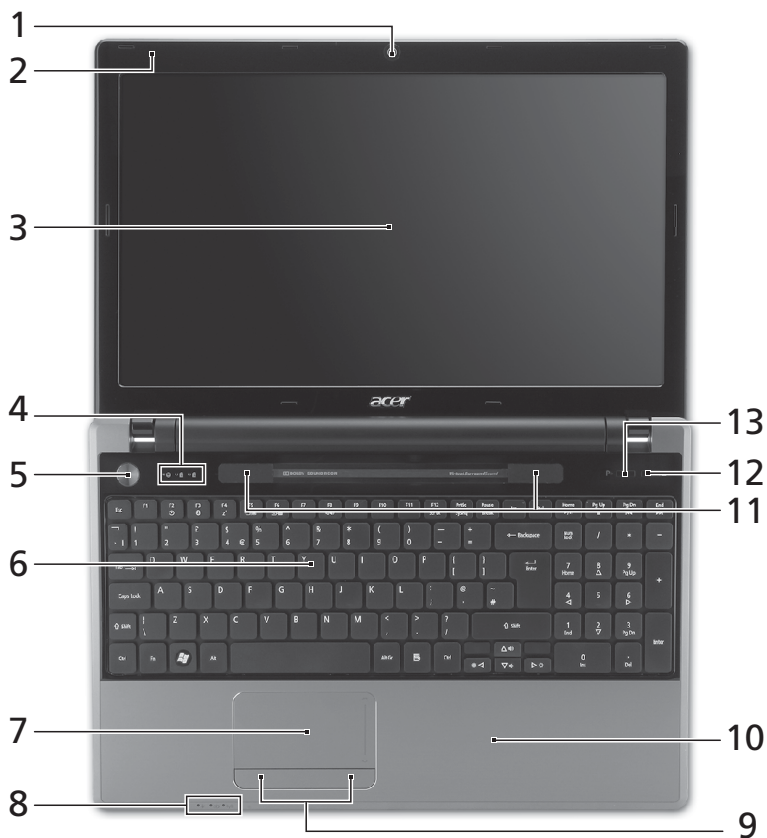



# Visita guiada ao seu computador portátil Acer

Após montar o computador tal como indicado na ilustração do cartaz, deixe-nos mostrar-lhe o seu novo computador portátil Acer.

## Vista de cima



#	Ícone	Item	Descrição
1		Webcam Acer Crystal Eye	Webcam para comunicação por vídeo (apenas para determinados modelos).

#	Ícone	Item	Descrição
2		Microfone	Microfone interno para gravação de som.
3		Ecrã	Também chamado ecrã de cristais líquidos (LCD), permite visualizar a informação do computador (a configuração pode variar consoante o modelo).
4		Indicador HDD	Indica quando o disco rígido está activo.
		Indicador Num Lock	Acende-se quando a função Num Lock é activada.
		Indicador Caps Lock	Acende-se quando a função Caps Lock é activada.
5		Botão de alimentação	Liga e desliga o computador.
6		Teclado	Para introduzir informações no seu computador.
7		Teclado táctil	Dispositivo apontador sensível ao toque, que funciona como um rato de computador.
8		Indicador de alimentação <sup>1</sup>	Indica o estado da alimentação do computador.
		Indicador da bateria <sup>1</sup>	Indica o estado da bateria do computador. <b>1. A carregar:</b> A luz é âmbar quando a bateria está a carregar. <b>2. Carga completa:</b> A luz é azul no modo CA.
		Indicador de comunicação <sup>1</sup>	Indica o estado do dispositivo de ligação sem fios do computador.
9		Botões de clique (esquerdo e direito)	Os botões esquerdo e direito funcionam como os botões esquerdo e direito de um rato.
10		Descanso de mãos	Área confortável de apoio para as suas mãos enquanto utiliza o computador.
11		Altifalantes	Os altifalantes esquerdo e direito permitem saída de áudio estéreo.
12		Botão de ejeção da unidade óptica	Ejecta o disco óptico da unidade.
13		Tecla programável	Programável pelo utilizador (apenas para determinados modelos).
		Tecla PowerSmart	Coloca o seu computador em modo de poupança de energia (apenas para determinados modelos).

1. Os indicadores no painel dianteiro são visíveis mesmo com a tampa do monitor fechada.

## Teclas de atalho

O computador utiliza teclas de atalho ou combinações de teclas para aceder à maior parte dos seus comandos, tais como a luminosidade do ecrã e o volume de saída.

Para activar as teclas de atalho, prima e mantenha premida a tecla **<Fn>** antes de premir a outra tecla na combinação de teclas de atalho.

Tecla de atalho	Ícone	Função	Descrição
<Fn> + <F3>		Tecla de comunicações	Activa/desactiva os dispositivos de comunicação do computador (Os dispositivos de comunicação podem variar consoante a configuração).
<Fn> + <F4>		Suspensão	Coloca o computador no modo de Suspensão.
<Fn> + <F5>		Comutação de visualização	Alterna a saída entre o ecrã de visualização, o monitor externo (se está ligado) e ambos.
<Fn> + <F6>		Ecrã desligado	Desliga a luz de fundo do ecrã de visualização para economizar energia. Prima qualquer tecla para retomar a actividade.
<Fn> + <F7>		Comutação de touchpad (teclado táctil)	Liga e desliga o teclado táctil interno.
<Fn> + <F8>		Comutação de altifalante	Liga e desliga os altifalantes.
<Fn> + <↑>		Aumentar luminosidade	Aumenta a luminosidade do ecrã.
<Fn> + <↓>		Reduzir luminosidade	Reduz a luminosidade do ecrã.
<Fn> + <△>		Aumentar volume	Aumenta o volume de som.
<Fn> + <▽>		Diminuir volume	Diminui o volume de som.
<Fn> + <Home>		Reproduzir/Pausa	Reproduz ou pausa um ficheiro multimédia seleccionado.
<Fn> + <Pg Up>		Parar	Para a reprodução do ficheiro multimédia seleccionado.
<Fn> + <Pg Dn>		Anterior	Retorna ao ficheiro multimédia anterior.
<Fn> + <End>		Seguinte	Avança até ao ficheiro multimédia seguinte.



## Visão frontal enquanto fechado



#	Ícone	Item	Descrição
1		Leitor de cartões vários-em-um	<p>Aceita cartões Secure Digital (SD), MultiMediaCard (MMC), Memory Stick (MS), Memory Stick PRO (MS PRO), xD-Picture Card (xD).</p> <p><b>Nota:</b> Empurre para remover/installar o cartão. Apenas pode ser utilizado um cartão de cada vez.</p>

## Vista direita



#	Ícone	Item	Descrição
1		Entrada USB 2.0	Liga a dispositivos USB 2.0 (por exemplo, rato USB, câmara USB).
2		Unidade óptica	Unidade óptica interna; aceita CD ou DVD.
3		Indicador de acesso do disco óptico	Acende quando a unidade óptica está activa.
4		Furo de ejeção de emergência	Ejecta o tabuleiro da unidade óptica quando o computador está desligado. <b>Nota:</b> Introduza um clipe no orifício de ejeção de emergência, para a unidade óptica ejectar o tabuleiro quando desligado o computador.
5		Tomada de entrada CC	Liga a um adaptador CA.



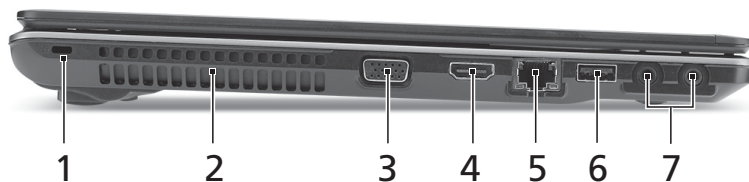

## Visão do lado esquerdo

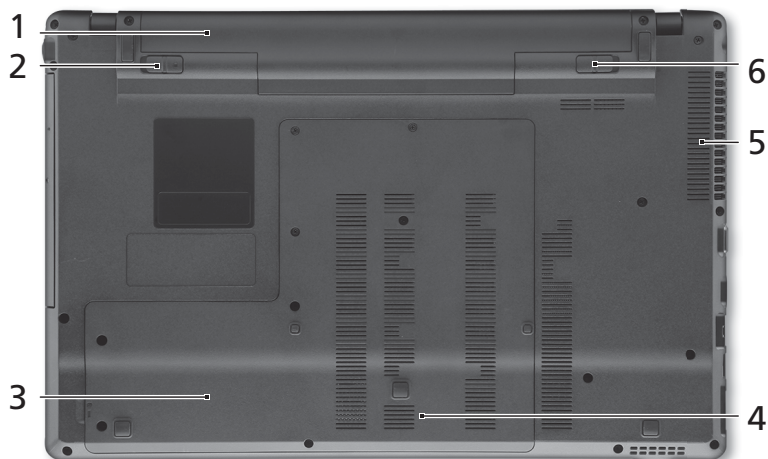

#	Ícone	Item	Descrição
1		Ranhura de bloqueio Kensington	Liga a um cadeado de segurança Kensington (ou compatível).
2		Ranhuras de ventilação	Permite ao computador manter-se fresco, mesmo após uso prolongado.
3		Ligação a ecrã externo (VGA)	Liga a um dispositivo de visualização (por exemplo, monitor externo, projector LCD).
4		Porta HDMI	Suporta ligações de vídeo digital de alta definição.
5		Entrada Ethernet (RJ-45)	Liga a uma rede Ethernet de base 10/100/1000.
6		Entrada USB 2.0	Liga a dispositivos USB 2.0 (por exemplo, rato USB, câmara USB).
7		Tomada para microfone	Aceita entradas de microfones externos.
		Tomada de auscultadores/altifalante/saída compatível com S/PDIF	Liga a dispositivos de saída de áudio (por exemplo, altifalantes, auscultadores).

## Visão da base



#	Ícone	Item	Descrição
1		Baía da bateria	Contém a bateria do computador.
2		Bloqueio da bateria	Bloqueia a bateria, mantendo-a no sítio.
3		Compartimento do disco rígido	Aloja o disco rígido do computador (seguro por parafusos).
4		Compartimento da memória	Aloja a memória principal do computador.
5		Ranhuras de ventilação e ventoinha de arrefecimento	Permite ao computador manter-se fresco, mesmo após uso prolongado. <b>Nota:</b> Não tape nem obstrua a abertura da ventoinha.
6		Patilha de libertação da bateria	Liberta a bateria para remoção.

## Ambiente

---

- Temperatura:
    - Funcionamento: 5°C a 35°C
    - Não em funcionamento: -20°C a 65°C
  - Humidade (não condensação):
    - Funcionamento: 20% a 80%
    - Não em funcionamento: 20% a 80%
- 



.....

**Nota:** As especificações acima listadas servem apenas como referência. A configuração exacta do seu PC depende do modelo adquirido.

# Aspire 5745/5553 Serie

Snelgids

© 2010 Alle rechten voorbehouden.

Snelgids voor de Aspire 5745/5553 Serie  
Oorspronkelijke uitgave: 03/2010

Aspire 5745/5553 Serie Notebook PC

Modelnummer: \_\_\_\_\_

Serienummer: \_\_\_\_\_

Aankoopdatum: \_\_\_\_\_

Plaats van aankoop: \_\_\_\_\_

# Voordat u aan de slag gaat

Bedankt dat u hebt gekozen voor een notebook van Acer als oplossing voor uw mobiele computereisen.

## Uw gidsen

Om u te helpen met het werken op het Acer notebook hebben we een aantal gidsen ontworpen:

Allereerst helpt de kaart **Aan de slag...** u bij het instellen van uw computer.

De **Algemene gebruikershandleiding van de Aspire Series** bevat handige informatie die van toepassing zijn op alle modellen uit de Aspire productreeks. De handleiding behandelt basale onderwerpen, zoals de het gebruik van het toetsenbord, geluid, enz. Vandaar dat zowel de **Algemene gebruikershandleiding** als de hieronder genoemde **AcerSystem User Guide** af en toe naar functies of kenmerken verwijzen die slechts voor enkele modellen in de reeks gelden, en dus niet noodzakelijk voor het model dat u heeft aangeschaft. Dit wordt in de tekst aangegeven met opmerkingen in de trand van "alleen voor bepaalde modellen".

Met de **Snelgids** krijgt u een introductie in de basiseigenschappen en functies van uw nieuwe computer. Als u meer wilt weten over hoe uw computer u kan helpen productiever te werken, raadpleeg dan de **AcerSystem User Guide**. Deze Gebruikershandleiding bevat gedetailleerde informatie over onderwerpen zoals systeemfuncties, gegevensherstel, uitbreidingsopties en probleem oplossen. Daarnaast bevat het informatie over garantie en de algemene voorwaarden en veiligheid voor uw notebook. Het is als Portable Document Format (PDF) beschikbaar en is al van te voren op uw notebook gezet. Volg deze stappen voor toegang tot dit document:

- 1 Klik op  **Start > Alle Programma's > AcerSystem**.
- 2 Klik vervolgens op **AcerSystem User Guide**.





**Opmerking:** Als u het bestand wilt inzien, dient Adobe Reader te zijn geïnstalleerd. Als Adobe Reader nog niet op uw computer is geïnstalleerd, wordt, als u op **AcerSystem User Guide** klikt, eerst het installatieprogramma van Adobe Reader gestart. Volg de instructies op het scherm om het programma te installeren. Gebruiksaanwijzingen bij Adobe Reader vindt u in het menu **Help en Ondersteuning**.

# Rondleiding door uw Acer notebook



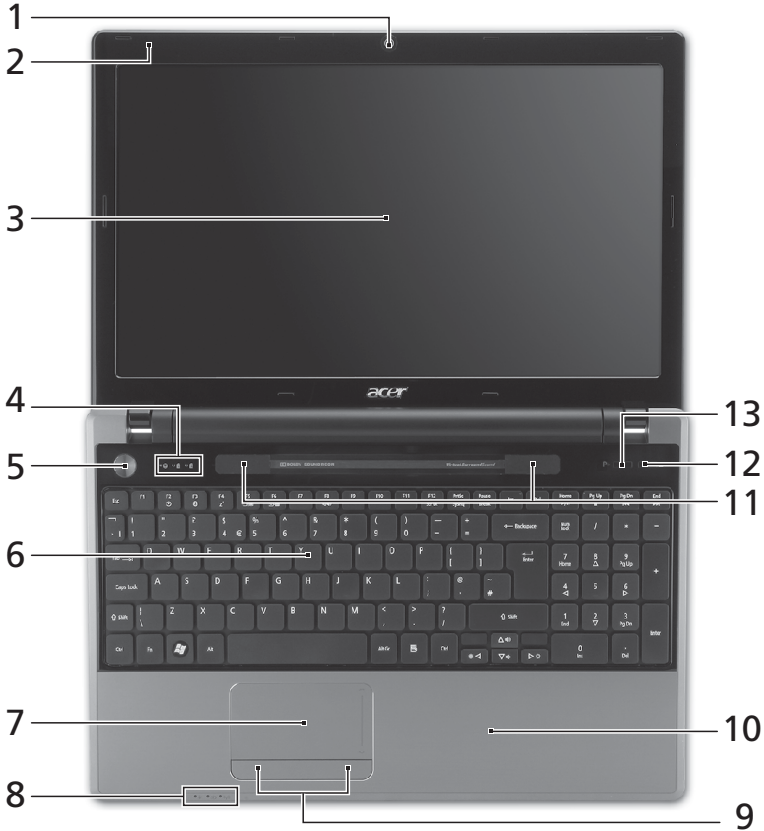





Nadat u de computer hebt ingesteld zoals is beschreven op de poster, bent u nu klaar voor een rondleiding door de nieuwe Acer notebook.

## Bovenkant



#	Pictogram	Item	Beschrijving
1		Acer Crystal Eye webcam	Webcam voor videocommunicatie (alleen voor bepaalde modellen).
2		Microfoon	Interne microfoon voor geluidsopname.













#	Pictogram	Item	Beschrijving
3		Beeldscherm	Ook wel Liquid-Crystal Display (LCD) genoemd, geeft de output van de computer weer (configuratie kan per model verschillen).
4		HDD-indicator	Licht op wanneer de harde schijf actief is.
		Num Lock-indicator	Brandt wanneer het Num Lock is ingeschakeld.
		Caps Lock-indicator	Brandt wanneer het Caps Lock is ingeschakeld.
5		Aan/uit knop	Schakelt de computer aan en uit.
6		Toetsenbord	Om gegevens in te voeren in de computer.
7		Touchpad	Tastgevoelig aanwijsapparaat dat functioneert als een computermuis.
8		Stroomindicator <sup>1</sup>	Geeft de vermogenstatus van de computer aan.
		Accu-indicator <sup>1</sup>	Geeft de batterijstatus van de computer aan. <b>1. Opladen:</b> Het licht is oranje wanneer de accu wordt opgeladen. <b>2. Volledig opgeladen:</b> Het licht is blauw in de AC-modus.
		Communicatie-indicator <sup>1</sup>	Geeft de apparaatstatus van de draadloze verbindingen van de computer aan.
9		Kliktoetsen (links en rechts)	De toetsen links en rechts functioneren als de linker en rechter muistoetsen.
10		Polssteun	Comfortabele ondersteuning voor uw handen wanneer u de computer gebruikt.
11		Luidsprekers	De luidsprekers links en rechts zorgen voor stereogeluid.
12		Uitwerpknop optisch station	Werpt de optische schijf uit het station.
13		Programmeerbare toets	Programmeerbaar door gebruiker (alleen voor bepaalde modellen).
		PowerSmart-toets	Plaatst de computer in de energie besparende modus (alleen voor bepaalde modellen).

1. De statusindicatoren aan de voorkant zijn zelfs zichtbaar als het scherm gesloten is.

## Sneltoetsen

De computer gebruikt sneltoetsen of toetscombinaties voor toegang tot de meeste besturingselementen, zoals helderheid en geluidsvolume.

Om een sneltoets te gebruiken drukt u de **<Fn>** -toets in voordat u de andere toets van de combinatie indrukt.

Sneltoets	Pictogram	Functie	Beschrijving
<b>&lt;Fn&gt; + &lt;F3&gt;</b>		Communicatietoets	Schakelt de communicatieapparaten van de computer in/uit (Communicatieapparaten kunnen verschillen per configuratie).
<b>&lt;Fn&gt; + &lt;F4&gt;</b>		Standby	Hiermee plaatst u de computer in de Standby-stand.
<b>&lt;Fn&gt; + &lt;F5&gt;</b>		Schakeltoets voor beeldscherm	Schakelt de weergave-uitvoer tussen het scherm, externe monitor (indien aangesloten) en beide.
<b>&lt;Fn&gt; + &lt;F6&gt;</b>		Beeldscherm uit	Hiermee schakelt u de lamp van het beeldscherm uit om stroom te besparen. Druk op een willekeurige toets om het beeldscherm weer te activeren.
<b>&lt;Fn&gt; + &lt;F7&gt;</b>		Schakeltoets voor touchpad	Hiermee schakelt u het interne touchpad in en uit.
<b>&lt;Fn&gt; + &lt;F8&gt;</b>		Schakeltoets voor luidspreker	Hiermee schakelt u de luidsprekers in en uit.
<b>&lt;Fn&gt; + &lt;&gt;&gt;</b>		Helderheid verhogen	Hiermee verhoogt u de helderheid van het beeldscherm.
<b>&lt;Fn&gt; + &lt;&lt;&lt;</b>		Helderheid verlagen	Hiermee verlaagt u de helderheid van het beeldscherm.
<b>&lt;Fn&gt; + &lt;Δ&gt;</b>		Volume omhoog	Hiermee verhoogt u het luidsprekervolume.
<b>&lt;Fn&gt; + &lt;∇&gt;</b>		Volume omlaag	Hiermee verlaagt u het luidsprekervolume.
<b>&lt;Fn&gt; + &lt;Home&gt;</b>		Afspelen/Pauze	Een geselecteerd mediabestand afspelen of pauzeren.

Sneltoets	Pictogram	Functie	Beschrijving
<Fn> + <Pg Up>	■	Stoppen	Het afspelen stoppen van het geselecteerde mediabestand.
<Fn> + <Pg Dn>	⏮	Vorige	Terugkeren naar het vorige mediabestand.
<Fn> + <End>	⏭	Volgende	Naar het volgende mediabestand springen.



## Voorkant gesloten



#	Pictogram	Item	Beschrijving
1		Meer-in-één-kaartlezer	Accepteert Secure Digital (SD), MultiMediaCard (MMC), Memory Stick (MS), Memory Stick PRO (MS PRO) en xD-Picture Card (xD). <b>Opmerking:</b> Duwen om de kaart te verwijderen/plaatsen. Slechts één kaart tegelijk mag gebruikt worden.

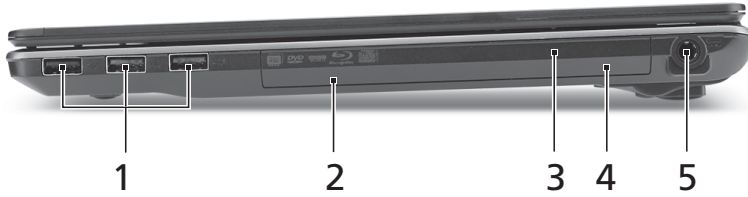





## Rechterkant

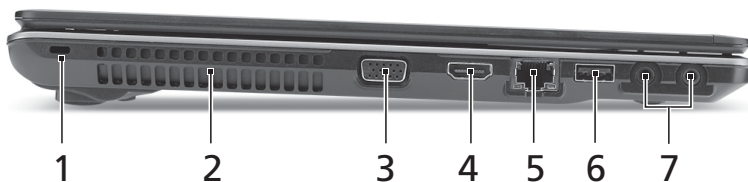

#	Pictogram	Item	Beschrijving
1		Usb 2.0-poort	Aansluitingen voor USB 2.0 apparaten (bijv. USB-muis, USB-camera).
2		Optisch station	Intern optisch station; accepteert CDs of DVDs.
3		Toegangsindicator optische schijf	Brandt wanneer het optisch station actief is.
4		Nood-uitwerpopening	Opent de lade van het optisch station wanneer de computer is uitgeschakeld. <b>Opmerking:</b> Steek een paperclip in de nooduitwerpopening om de lade van het optisch station uit te werpen als de computer is uitgeschakeld.
5		Gelijkstroomaansluiting	Aansluiting voor een adapter.





## Linkerkant

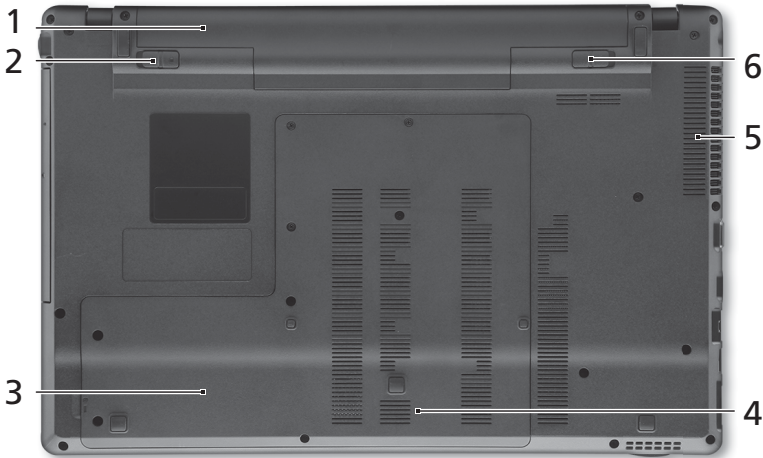

#	Pictogram	Item	Beschrijving
1		Sleuf voor Kensington-slot	Aansluiting voor een Kensington-compatibel computerbeveiligingsslot.
2		Ventilatie-sleuven	Zorgen dat de computer koel blijft, zelfs na langdurig gebruik.
3		Externe weergavepoort (VGA)	Aansluiting voor een beeldscherm (bijv. een externe monitor, LCD-projector).
4		Hdmi-poort	Ondersteunt high-definition digitale videosignalen.
5		Ethernetpoort (RJ-45)	Aansluiting voor een Ethernet 10/100/1000-gebaseerd netwerk.
6		Usb 2.0-poort	Aansluitingen voor USB 2.0 apparaten (bijv. USB-muis, USB-camera).
7		Microfoonaansluiting	Aansluitingen voor externe microfoon.
		S/PDIF-ondersteuning voor hoofdtelefoon/luidspreker/lijn-uit	Aansluiting voor lijn-uit audioapparaten (bijv. luidsprekers, hoofdtelefoon).

## Onderkant



#	Pictogram	Item	Beschrijving
1		Batterijnis	Bevat de batterij van de computer.
2		Batterijgrendel	Vergrendelt de accu op z'n plaats.
3		Harde schijf nis	Bevat de harde schijf van de computer (vastgeschroefd).
4		Geheugenvak	Bevat het hoofdgeheugen van de computer.
5		Ventilatiesleuven en koelventilator	Zorgen dat de computer koel blijft, zelfs na langdurig gebruik. <b>Opmerking:</b> Dek de opening van de ventilator nooit af.
6		Batterijvergrendeling	Maakt de batterij los.

## Omgeving

---

- **Temperatuur:**
    - In gebruik: 5°C tot 35°C
    - Niet in gebruik: -20°C tot 65°C
  - **Vochtigheidsgraad (geen condensvorming):**
    - In gebruik: 20% tot 80%
    - Niet in gebruik: 20% tot 80%
- 



.....

**Opmerking:** Bovenstaande specificaties dienen slechts ter referentie. De exacte configuratie van de PC is afhankelijk van het aangeschafte model.





# Aspire 5745/5553-serien

Hurtigguide

© 2010 Med enerett.

Hurtigguide for Aspire 5745/5553-serien  
Opprinnelig utgave: 03/2010

Notebook-PC i Aspire 5745/5553-serien

Modellnummer: \_\_\_\_\_

Serienummer: \_\_\_\_\_

Innkjøpsdato: \_\_\_\_\_

Innkjøpssted: \_\_\_\_\_

# Begynne med begynnelsen

Vi vil gjerne takke deg for at du har valgt en Acer-notebook til dine mobile databehandlingsbehov.

## Dine veiledere

Som hjelp til bruk av Acer-notebooken har vi utformet et sett av veiledere:

Til å begynne med vil plakaten **Før vi begynner...** hjelpe deg med å komme i gang med oppsettet av datamaskinen.

Den **generiske håndboken for Aspire-serien** inneholder nyttig informasjon om alle modeller i Aspire-produktserien. Den dekker grunnleggende emner som bruk av tastaturet, lyd, osv. Vennligst merk at både den **generiske håndboken** og **AcerSystem User Guide** som er nevnt nedenfor, fra tid til annen vil referere til funksjoner eller egenskaper som bare finnes på visse modeller, men ikke nødvendigvis på modellen du kjøpte. Slike forekomster er markert i teksten med kommentarer som "bare for visse modeller".

I den **Hurtigguide** får du en innføring i de grunnleggende egenskapene og funksjonene til den nye datamaskinen. Hvis du vil vite mer om hvordan datamaskinen kan gjøre deg mer produktiv, kan du slå opp i **AcerSystem User Guide**. Denne håndboken inneholder detaljert informasjon om emner som systemverktøy, datagjenvinning, utvidelsesalternativer og feilsøking/problemløsning. I tillegg finner du garantiopplysninger, generell informasjon og sikkerhetsmerknader for notisbokmaskinen din. Boken er tilgjengelig som PDF-fil (Portable Document Format) og leveres forhåndslastet på maskinen. Følg disse trinnene for å åpne den:

- 1 Klikk på  **Start > Alle Programmer > AcerSystem**.
- 2 Klikk på **AcerSystem User Guide**.



.....

**Merk:** Visning av filen krever at du har Adobe Reader installert. Hvis Adobe Reader ikke er installert på datamaskinen din, vil klikking på **AcerSystem User Guide** føre til at installeringsprogrammet for Adobe Reader kjøres i stedet. Følg instruksjonene på skjermen for å fullføre installeringen. Hvis du vil vite hvordan du bruker Adobe Reader, åpner du menyen **Hjelp og Støtte**.







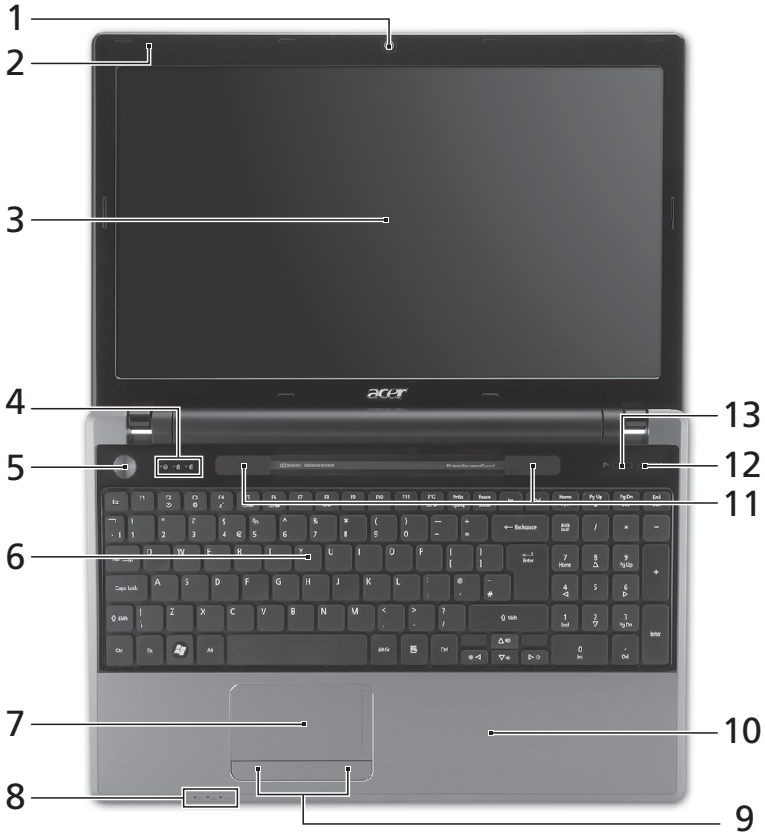

# En omvisning i Acer-notebooken

Når du har satt opp datamaskinen som vist på plakaten, la oss ta en omvisning i din nye Acer-notisbokmaskin.

## Visning ovenfra



#	Ikon	Element	Beskrivelse
1		Acer Crystal Eye-webkamera	Webkamera til videokommunikasjon (bare for visse modeller).
2		Mikrofon	Intern mikrofon for lydinnspilling.















#	Ikon	Element	Beskrivelse
3		Skjerm	Kalles også LCD-skjerm (Liquid-Crystal Display; LCD), viser utdata fra datamaskinen (konfigurasjonen kan variere mellom modellene).
4		Harddiskindikator	Lyser når harddisken er aktiv.
		Num Lock-indikator	Lyser når Num Lock er aktivert.
		Caps Lock-indikator	Lyser når Caps Lock er aktivert.
5		Av/på-knapp	Slår datamaskinen av og på.
6		Tastatur	Legger inn data i datamaskinen.
7		Pekeplate	Pekeenhet som reagerer på berøring og fungerer som en mus.
8		Strømindikator <sup>1</sup>	Angir datamaskinens strømstatus.
		Batteriindikator <sup>1</sup>	Angir datamaskinens batteristatus. <b>1. Lading:</b> Lampen lyser gult når batteriet lades. <b>2. Helt oppladet:</b> Lampen lyser blått i nettstrømmodus.
		Kommunikasjonssindikator <sup>1</sup>	Angir datamaskinens status for trådløs tilkobling.
9		Klikkeknapper (venstre og høyre)	Venstre og høyre knapp fungerer på samme måte som venstre og høyre museknapp.
10		Håndleddshviler	Komfortabelt støtteområde for hendene når du bruker datamaskinen.
11		Høytalere	Venstre og høyre høytaler leverer stereolyd.
12		Utløserknapp for optisk stasjon	Løser ut den optiske disken fra stasjonen.
13		Programmerbar tast	Brukerprogrammerbar (bare for visse modeller).
		PowerSmart-tast	Setter datamaskinen i strømsparingsmodus (bare for visse modeller).

1. Frontpanelindikatorene er synlige selv når skjermen er lukket.

## Hurtigtaster

Datamaskinen bruker hurtigtaster eller tastekombinasjoner for å få tilgang til datamaskinens kontroller, for eksempel skjermens lysstyrke og volumutgang.

Når du skal aktivere hurtigtaster, trykker du på og holder <Fn>-tasten før du trykker på den neste tasten i hurtigtastkombinasjonen.

Hurtigtast	Ikon	Funksjon	Beskrivelse
<Fn> + <F3>		Kommunikasjonstast	Aktiverer/deaktiverer datamaskinens kommunikasjonsenheter (Kommunikasjonsenheter kan variere i konfigurasjon).
<Fn> + <F4>		Dvale	Setter datamaskinen i dvalemodus.
<Fn> + <F5>		Skjermbytte	Bytter mellom visning på vanlig skjerm, ekstern skjerm (hvis tilkoblet) eller begge deler.
<Fn> + <F6>		Visning av	Slå av skjermens bakgrunnsbelysning for å spare strøm. Trykk på en hvilken som helst tast for å gå tilbake.
<Fn> + <F7>		Berøringsplate av/på	Slår den interne berøringsplaten av og på.
<Fn> + <F8>		Høytaler av/på	Slår høytalerne av og på.
<Fn> + <D>		Lysstyrke opp	Øker skjermens lysstyrke.
<Fn> + <D>		Lysstyrke ned	Reduserer skjermens lysstyrke.
<Fn> + <Δ>		Volum opp	Øker lydvolument.
<Fn> + <∇>		Volum ned	Reduserer lydvolument.
<Fn> + <Home>		Spill av/pause	Spill av eller pause en valgt mediefil.
<Fn> + <Pg Up>		Stopp	Stopp avspilling av den valgte mediefilen.
<Fn> + <Pg Dn>		Forrige	Returner til forrige mediefil.
<Fn> + <End>		Neste	Hopp til neste mediefil.

## Lukket frontvisning



#	Ikonelement	Beskrivelse
1		Godtar Secure Digital (SD), MultiMediaCard (MMC), Memory Stick (MS), Memory Stick Pro (MS PRO), og xD-Picture Card (xD). <b>Merk:</b> Skyv inn for å fjerne/installere kortet. Bare ett kort kan operere til enhver tid.







## Høyre visning

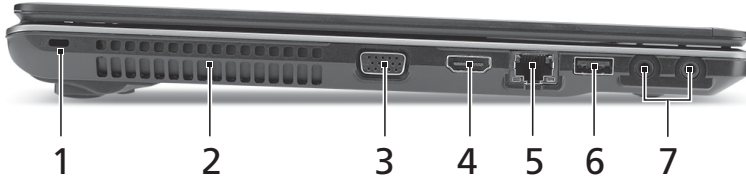

#	Ikonelement	Beskrivelse
1		Kobler til USB 2.0-enheter (f.eks. USB-mus, USB-kamera).
2		Intern optisk stasjon. Godtar CDer og DVDer.
3		Lyser når den optiske stasjonen er aktiv.
4		Løser ut platen i den optiske stasjonen når datamaskinen er slått av. <b>Merk:</b> Sett en binders i nødutløserhullet hvis du må løse ut den optiske stasjonen når datamaskinen er av.
5		Kobler til en batterieliminertor.

## Venstre visning







#	Ikon	Element	Beskrivelse
1		Spor for Kensington-lås	Kobler til en Kensington-kompatibel sikkerhetslås for datamaskinen.
2		Ventilasjonsåpninger	Gir datamaskinen mulighet til å holde seg kjølig, selv etter lang tids bruk.
3		Port for ekstern skjerm (VGA)	Kobler til en skjermenhet (f.eks. ekstern skjerm, LCD-projektor).
4		HDMI-port	Støtter høydefinisjons digitale videoforbindelser.
5		Ethernet-port (RJ-45)	Kobler til et Ethernet 10/100/1000-basert nettverk.
6		USB 2.0-port	Kobler til USB 2.0-enheter (f.eks. USB-mus, USB-kamera).
7		Mikrofonport	Mottar inndata fra eksterne mikrofoner.
	 SPDIF	Hodetelefon/ høyttalere/line-out- port med S/PDIF-støtte	Kobles til utdataenheter for lyd (f.eks. høyttalere, hodetelefoner).

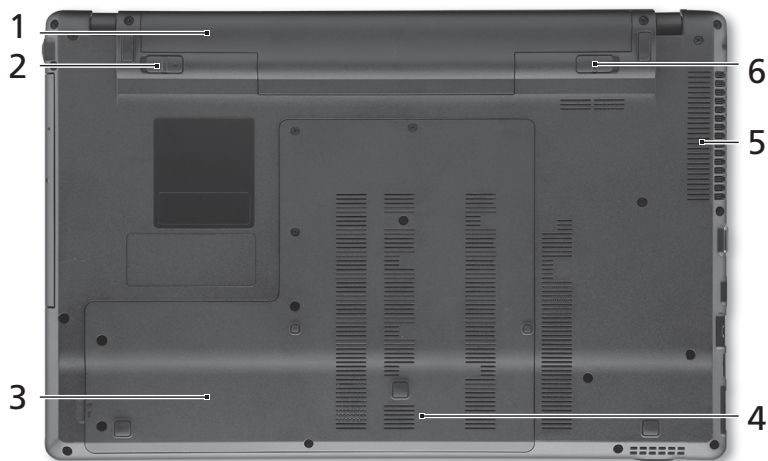

## Bunnvisning



#	Ikone	Element	Beskrivelse
1		Batterirom	Huser datamaskinens batterier.
2		Batterilås	Låser batteriet på plass.
3		Harddiskplass	Huser datamaskinens harddisk (sikret med skruer).
4		Minnerom	Huser datamaskinens hovedminne.
5		Ventilasjonsåpninger og kjølevifte	Gir datamaskinen mulighet til å holde seg kjølig, selv etter lang tids bruk. <b>Merk:</b> Ikke dekk til eller blokker viftens åpning.
6		Batterifrigivelsesbolt	Frigir batteriet for fjerning.

## Miljø

---

- Temperatur:
    - Drift: 5°C til 35°C
    - Ikke i bruk: -20°C til 65°C
  - Luftfuktighet (ikke-kondenserende):
    - Drift: 20% til 80%
    - Ikke i bruk: 20% til 80%
- 



.....

**Merk:** Spesifikasjonene ovenfor er kun for referanseformål.  
PCens eksakte konfigurasjon avhenger av den kjøpte modellen.

# Aspire 5745/5553 Seriens

Hurtig-guide

© 2010 Alle Rettigheder Forbeholdes.

Aspire 5745/5553 Seriens Hurtig-guide  
Oprindeligt udgivet: 03/2010

Aspire 5745/5553 seriens notebook-pc

Modelnummer: \_\_\_\_\_

Serienummer: \_\_\_\_\_

Købsdato: \_\_\_\_\_

Købt hos: \_\_\_\_\_

# Generelle oplysninger

Tak, fordi du har valgt en Acer notebook som din mobile computer.

## Vejledninger

Vi har udarbejdet et sæt vejledninger til at hjælpe dig med at anvende din Acer notebook.

Først og fremmest bogen **Sådan kommer du i gang...**, som hjælper dig med opsætning af computeren.

Den **Aspire seriens Fælles brugervejledning** indeholder nyttige oplysninger, der gælder alle modellerne i Aspire produktserien. Den dækker grundlæggende emner som f. eks. brug af tastatur, lyd etc. Husk venligst, at **Fælles brugervejledning** såvel som **AcerSystem User Guide** nævnt nedenfor henviser nogle gange til funktioner eller kapaciteter, der kun findes i udvalgte modeller, og ikke nødvendigvis i den model du købte. I disse tilfælde er teksten markeret med f. eks. "kun for udvalgte modeller".

Den **Hurtig-guide** beskriver de grundlæggende egenskaber og funktioner ved din nye computer. Du kan finde flere oplysninger om, hvordan computeren kan hjælpe dig til at blive mere produktiv, i **AcerSystem User Guide**. Denne vejledning indeholder detaljerede oplysninger om emner som systemprogrammer, datagendannelse, udvidelsesmuligheder og fejlfinding. Den indeholder desuden garantioplysninger samt generelle bestemmelser og sikkerhedsbemærkninger til notebook-computeren. Den er tilgængelig i PDF-format (Portable Document Format) og er forudinstalleret på notebook-pc. Følg disse trin for at få adgang til den:

- 1 Klik på  **Start > Alle programmer > AcerSystem**.
- 2 Klik på **AcerSystem User Guide**.



.....

**Bemærk:** For at få vist filen skal du have Adobe Reader installeret. Hvis Adobe Reader ikke er installeret på din computer, kører installationsprogrammet til Adobe Reader automatisk, når du klikker på **AcerSystem User Guide**. Følg vejledningen på skærmen for at afslutte installationen. Yderligere oplysninger om, hvordan du bruger Adobe Reader, finder du i menuen **Hjælp og Support**.







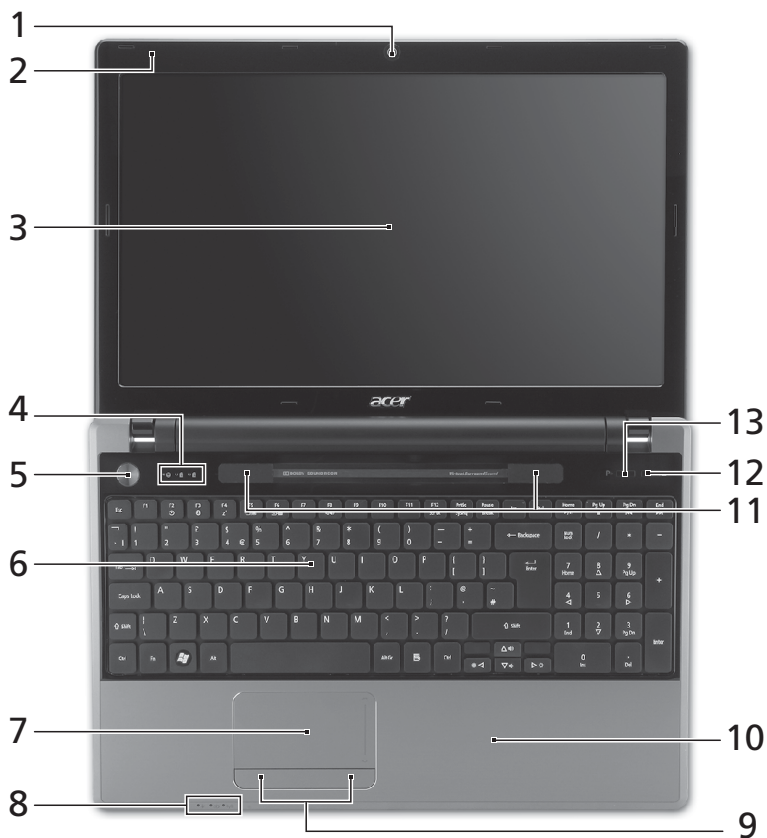

# En præsentation af din Acer notebook

Når du har sat computeren op som vist på illustrationerne på plakaten, bør du bruge et par minutter på at lære din nye Acer notebook at kende.

## Fra oven



#	Ikon	Emne	Beskrivelse
1		Acer Crystal Eye webcam	Webkamera til videokommunikation (kun for udvalgte modeller).















#	Ikon	Emne	Beskrivelse
2		Mikrofon	Intern mikrofon til optagelse af lyd.
3		Skærm	Det kaldes også for et LCD (Liquid-Crystal Display - flydende krystaldisplay), og det viser computerens output (konfiguration kan variere fra model til model).
4		Harddiskindikator	Lyser, når harddisken er aktiv.
		Num lock-indikator	Lyser, når Num Lock er aktiveret.
		Caps Lock-indikator	Lyser, når Caps Lock er aktiveret.
5		Afbryderknop	Tænder/slukker for computeren.
6		Tastatur	Til indtastning af data på computeren.
7		Touchpad (pegefelt)	Et berøringsfølsomt pegerebskab, der fungerer ligesom en computermus.
8		Strømindikator <sup>1</sup>	Angiver computerens strømstatus.
		Batteriindikator <sup>1</sup>	Angiver computerens batteristatus. <b>1. Oplader:</b> Lampen lyser gult, når batteriet oplader. <b>2. Fuldt opladet:</b> Lampen lyser blå i AC-tilstand.
		Kommunikation-sindikator <sup>1</sup>	Angiver status for computerens trådløse enhedsforbindelse.
9		Klik-knapper (til venstre og til højre)	Knapperne til højre og venstre fungerer på samme måde som musens højre og venstre knapper.
10		Håndfladestøtte	Et komfortabelt støtteområde for dine hænder, når du bruger computeren.
11		Højtalere	Venstre og højre højttalere udsender lyd i stereo.
12		Udløserknop for det optiske drev	Skubber den optiske disk ud ad drevet.
13	<b>P</b>	Programmerbar taste	Brugerprogrammerbar (kun for udvalgte modeller).
		PowerSmart-taste	Sætter din computer i strømbesparelæstilstand (kun for udvalgte modeller).

1. Frontpanelets indikatorer er synlige, selvom computerens låg er lukket.

## Hurtigtaster

Computeren bruger hurtigtaster eller tastkombinationer til at få adgang til de fleste af computerens kontroller som skærmens lysstyrke og lydstyrke.

Hvis du vil aktivere hurtigtaster, skal du holde **<Fn>**-tasten nede og derefter trykke på den anden tast i hurtigtastkombinationen.

Hurtigtast	Ikon	Funktion	Beskrivelse
<b>&lt;Fn&gt; + &lt;F3&gt;</b>		Kommunikationstaste	Aktiverer/deaktiverer computerens kommunikationsenheder (Kommunikationsenheder kan variere efter konfiguration).
<b>&lt;Fn&gt; + &lt;F4&gt;</b>		Dvale	Sætter computeren i dvaletilstand.
<b>&lt;Fn&gt; + &lt;F5&gt;</b>		Skærm til/fra	Skifter skærmoutputtet mellem skærmen, en ekstern skærm (hvis den er tilsluttet) og begge to.
<b>&lt;Fn&gt; + &lt;F6&gt;</b>		Skærm fra	Slukker for skærmens baggrundslis for at spare strøm. Tryk på en vilkårlig tast for at fortsætte.
<b>&lt;Fn&gt; + &lt;F7&gt;</b>		Pegefelt til/fra	Tænder og slukker for det interne pegefelt.
<b>&lt;Fn&gt; + &lt;F8&gt;</b>		Højtaler til/fra	Tænder og slukker for højttalerne.
<b>&lt;Fn&gt; + &lt;▷&gt;</b>		Lysstyrke op	Forøger skærmens lysstyrke.
<b>&lt;Fn&gt; + &lt;◁&gt;</b>		Lysstyrke ned	Formindsker skærmens lysstyrke.
<b>&lt;Fn&gt; + &lt;△&gt;</b>		Lydstyrke op	Forøger højttalerens lydstyrke.
<b>&lt;Fn&gt; + &lt;▽&gt;</b>		Lydstyrke ned	Reducerer højttalerens lydstyrke.
<b>&lt;Fn&gt; + &lt;Home&gt;</b>		Afspil/Afbryd	Afspil eller stands midlertidigt en udvalgt mediefil.
<b>&lt;Fn&gt; + &lt;Pg Up&gt;</b>		Stop	Standser afspilningen af den valgte mediefil.
<b>&lt;Fn&gt; + &lt;Pg Dn&gt;</b>		Forrige	Går tilbage til forrige mediefil.
<b>&lt;Fn&gt; + &lt;End&gt;</b>		Næste	Springer til den næste mediefil.





## Set forfra - lukket



#	Ikon	Emne	Beskrivelse
1		Flere-i-en-kortlæser	Accepterer Secure Digital (SD), MultiMediaCard (MMC), Memory Stick (MS), Memory Stick PRO (MS PRO), og xD-Picture Card (xD). <b>Bemærk:</b> Skub for at fjerne/installere kortet. Der kan kun være et kort aktivt ad gangen.







## Fra højre

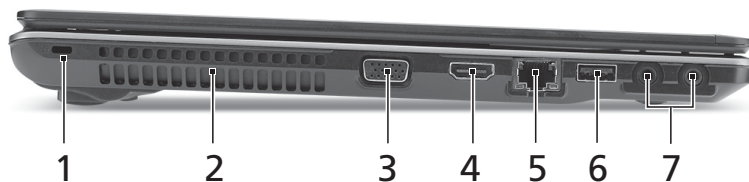

#	Ikon	Emne	Beskrivelse
1		USB 2.0-port	De er beregnet til tilslutning af to USB 2.0-enheder (f. eks. en USB-mus, USB-kamera).
2		Optisk drev	Internt optisk drev; accepterer CD'er og DVD'er.
3		Optisk disk - adgangsimpikator	Lyser når det optiske drev er aktivt.
4		Mekanisk udløserhul	Det åbner skuffen til det optiske drev, når computeren er slukket. <b>Bemærk:</b> Indsæt en papirklips i hullet til nødudskubning for at skubbe den optiske drevbakke ud, når computeren er slukket.
5		Jævnstrøm indstik	Tilslutter til en AC-adapter.





## Set fra venstre

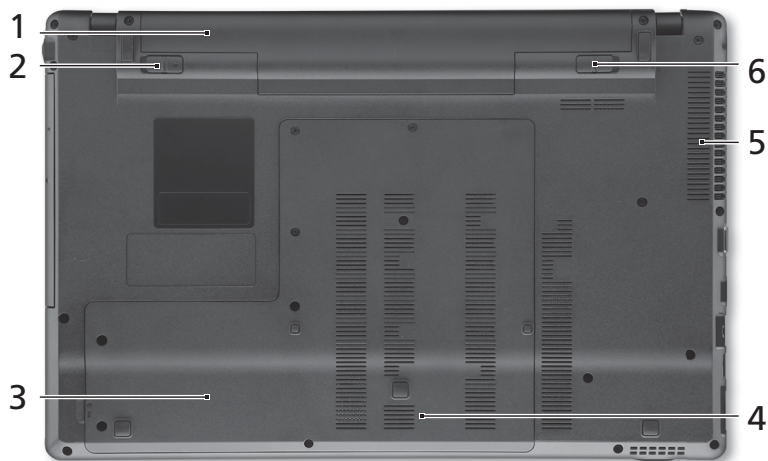

#	Ikon	Emne	Beskrivelse
1		Åbning til en Kensington-lås	Tilslutter til en Kensington-kompatibel computers sikkerhedslås.
2		Ventilationsåbninger	Lader computeren være kølig selv efter lang tids brug.
3		Stik til ekstern skærm (VGA)	Beregnet til tilslutning af en displayenhed (f. eks. ekstern skærm, LCD-projektor).
4		HDMI-port	Understøtter high-definition digitale netværksforbindelser.
5		Netværksport (RJ-45)	Til tilslutning af et Ethernet 10/100/1000-baseret netværk.
6		USB 2.0-port	De er beregnet til tilslutning af to USB 2.0-enheder (f. eks. en USB-mus, USB-kamera).
7		Mikrofonstik	Accepterer input fra eksterne mikrofoner.
		Hovedtelefoner/højttaler/udgangsstik med S/PDIF understøttelse	Der kan tilsluttes ekstraudstyr (f. eks. højttalere, hovedtelefoner).

## Set fra bunden



#	Ikon	Emne	Beskrivelse
1		Batterirum	Indeholder computerens batteri.
2		Batterilås	Låser batteriet på plads.
3		Harddiskbås	Indeholder computerens harddisk (fastsat med skruer).
4		Hukommelsesrum	Her sidder computerens centrale hukommelse.
5		Ventilationshuller og kølblæser	Lader computeren være kølig selv efter lang tids brug. <b>Bemærk:</b> Du må aldrig tildække eller spærre åbningen til køleren.
6		Frigørelsesarm til batteri	Frigør batteriet til udtagning.

## Omgivelser

---

- Temperatur:
    - Under brug: 5°C til 35°C
    - Ikke i brug: -20°C til 65°C
  - Fugtighed (ikke-kondenserende):
    - Under brug: 20% til 80%
    - Ikke i brug: 20% til 80%
- 



.....

**Bemærk:** Specifikationerne ovenfor er kun til reference.  
Den nøjagtige konfiguration af din pc afhænger af den købte model.

# Aspire 5745/5553-serien

Snabbguide

© 2010 Med ensamrätt.

Aspire 5745/5553-serien - Snabbguide  
Ursprunglig utgåva: 03/2010

Aspire 5745/5553-serien – bärbar PC-dator

Modellnummer: \_\_\_\_\_

Serienummer: \_\_\_\_\_

Inköpsdatum: \_\_\_\_\_

Inköpsställe: \_\_\_\_\_

# Välkommen!

Vi vill tacka för att du har valt en bärbar Acer-dator som kommer att uppfylla dina krav på bärbar datorbehandling.

## Dina handböcker

Vi har tagit fram en uppsättning guider som hjälper vid användning av din bärbara Acer-dator:

Till att börja med finns instruktionsfoldern **Börja med att läsa detta...** som hjälper dig komma igång med installationen av datorn.

Den **Allmän användarguide för Aspire-serien** innehåller användbar information som gäller alla modeller i Aspire-produktserien. Den omfattar grundläggande ämnen som användning av tangentbordet, ljud, osv. Var medveten om att **Allmän användarguide** samt **AcerSystem User Guide** som nämns nedan till följd av sin natur då och då hänvisar till funktioner som bara finns i vissa av seriens modeller men inte nödvändigtvis i den modell som du har köpt. Sådana exempel markeras i texten med fraser som "endast för vissa modeller".

I den **Snabbguide** presenteras de grundläggande funktionerna i din nya dator. Mer information om hur datorn kan hjälpa dig att bli mer produktiv finns i **AcerSystem User Guide**. Denna handbok innehåller detaljerad information om ämnen som systemverktyg, dataåterhämtning, expansionsalternativ och felsökning. Dessutom innehåller den garantiinformation och allmänna regler, samt säkerhetsnoteringar om din bärbara dator. Den är tillgänglig i Portable Document Format (PDF) och levereras förinstallerad i den bärbara datorn. Följ dessa steg för att få tillgång till den:

- 1 Välj  **Start > Alla program > AcerSystem.**
- 2 Dubbelklicka på **AcerSystem User Guide.**



.....

**Obs:** Du måste ha Adobe Reader installerat för att kunna visa filen. Om Adobe Reader inte är installerat på datorn kommer det att installeras när du dubbelklickar på **AcerSystem User Guide**. Utför installationen genom att följa instruktionerna på bildskärmen. Instruktioner för hur du använder Adobe Reader finns på menyn **Hjälp och Support**.

# Beskrivning av din bärbara Acer-dator





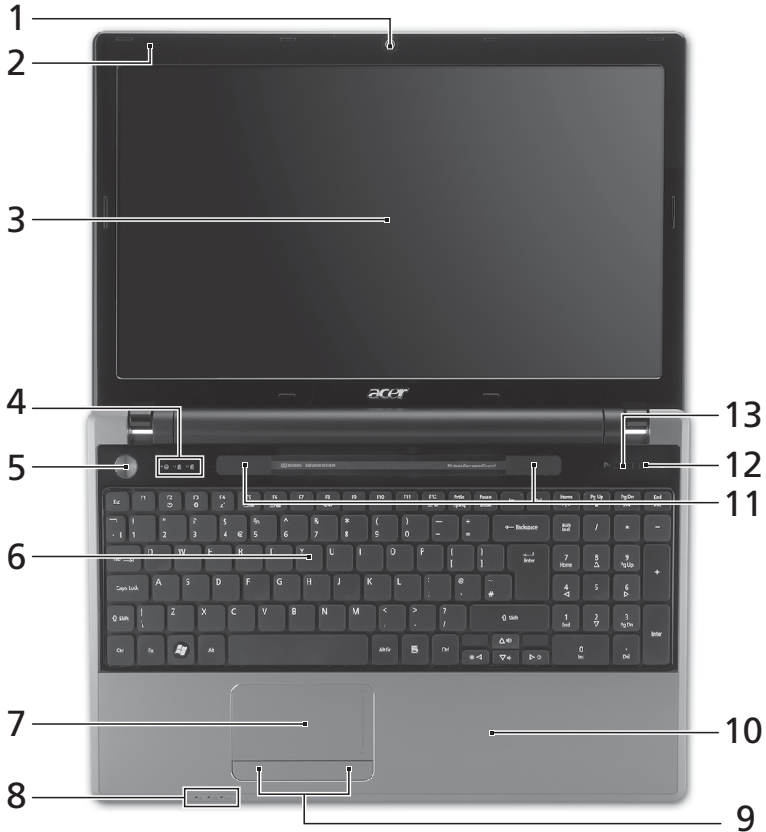



När du har installerat datorn enligt illustrationen i instruktionsfoldern vill vi beskriva din nya bärbara Acer-dator.

## Vy över ovansidan



#	Ikön	Objekt	Beskrivning
1		Acer Crystal Eye webbkamera	Webbkamera för videokommunikation (endast för vissa modeller).
2		Mikrofon	Inbyggd mikrofon för ljudinspelning.



#	Ikön	Objekt	Beskrivning
3		Bildskärm	Kallas även Liquid-Crystal Display (LCD), visar utdata från datorn (konfigurationen kan variera med olika modeller).
4		Hårddiskindikator	Tänds när hårddisken arbetar.
		Num Lock-indikator	Lyser när det Num Lock aktiveras.
		Caps Lock-indikator	Lyser när skiftlåset (Caps Lock) aktiveras.
5		Av/på-knapp	Slår på och stänger av datorn.
6		Tangentbord	För inmatning av data i datorn.
7		Pekplatta	Beröringskänslig pekenhet som fungerar som en datormus.
8		På-indikator <sup>1</sup>	Anger om datorn är av eller på.
		Batteriindikator <sup>1</sup>	Anger status för datorns batteri. <b>1. Laddar:</b> Lyser orange när batteriet laddas. <b>2. Fulladdad:</b> Lyser blått då datorn är ansluten till nätström.
		Kommunikationsindikator <sup>1</sup>	Anger status för datorns trådlösa anslutningsenhet.
9		Klickknappar (vänster och höger)	Vänster och höger knapp fungerar som vänster och höger musknapp.
10		Handlovsstöd	Handlovsstödet ger bekvämt stöd för händerna när du använder datorn.
11		Högtalare	Vänster och höger högtalare som ger stereoljud.
12		Utmatningsknapp för optisk läsenhet	Matar ut skivan från den optiska läsenheten.
13	<b>P</b>	Programmerbar knapp	Användarprogrammerbar (endast för vissa modeller).
		PowerSmart-knapp	Försätter datorn i energisparläge (endast för vissa modeller).

1. Indikatorerna på frontpanelen syns även när datorhöljet är stängt.

## Snabbtangenter

Datorn använder snabbtangenter eller tangentkombinationer för att komma åt de flesta av datorns kontroller som t.ex. skärmens ljusstyrka och volym.

Du aktiverar en snabbtangenter genom att hålla ned **<Fn>** innan du trycker på den andra tangenten i snabbtangentskombinationen.

Snabbtangent	Ikon	Funktion	Beskrivning
<b>&lt;Fn&gt; + &lt;F3&gt;</b>		Kommunikationstangent	Aktiverar/avaktiverar datorns kommunikationsenheter (Kommunikationsenheterna kan variera beroende på konfiguration).
<b>&lt;Fn&gt; + &lt;F4&gt;</b>		Vänteläge	Placerar datorn i vänteläge.
<b>&lt;Fn&gt; + &lt;F5&gt;</b>		Växla bildskärm	Växlar visning mellan datorns bildskärm och en extern monitor (om ansluten) och båda.
<b>&lt;Fn&gt; + &lt;F6&gt;</b>		Bildskärm av	Stänger av bildskärmens bakgrundsbelysning för att spara ström. Återgå genom att trycka på en valfri tangent.
<b>&lt;Fn&gt; + &lt;F7&gt;</b>		Aktivera/avaktivera pekplatta	Aktivera/inaktivera den interna pekplattan.
<b>&lt;Fn&gt; + &lt;F8&gt;</b>		Aktivera/avaktivera högtalare	Sätter på/stänger av högtalarna.
<b>&lt;Fn&gt; + &lt;▷&gt;</b>		Öka ljusstyrkan	Ökar bildskärmens ljusstyrka.
<b>&lt;Fn&gt; + &lt;◁&gt;</b>		Minska ljusstyrka	Minskar bildskärmens ljusstyrka.
<b>&lt;Fn&gt; + &lt;△&gt;</b>		Volym upp	Höjer högtalarvolymen.
<b>&lt;Fn&gt; + &lt;▽&gt;</b>		Volym ned	Sänker högtalarvolymen.
<b>&lt;Fn&gt; + &lt;Home&gt;</b>		Spela upp/pausa	Spelar upp eller pausar en vald mediefil.
<b>&lt;Fn&gt; + &lt;Pg Up&gt;</b>		Stopp	Stoppas uppspelning av valds mediefil.
<b>&lt;Fn&gt; + &lt;Pg Dn&gt;</b>		Föregående	Återgår till föregående mediefil.
<b>&lt;Fn&gt; + &lt;End&gt;</b>		Nästa	Hoppas till nästa mediefil.

## Vy framifrån med nedfälld skärm



#	Ikon	Objekt	Beskrivning
1		Flera-i-1-kortläsare	<p>Avsedd för Secure Digital (SD), MultiMediaCard (MMC), Memory Stick (MS), Memory Stick PRO (MS PRO), xD-Picture Card (xD).</p> <p><b>Obs!</b> Tryck för att ta bort/sätta i kortet. Endast ett enda kort kan vara aktivt åt gången.</p>







## Vy från höger

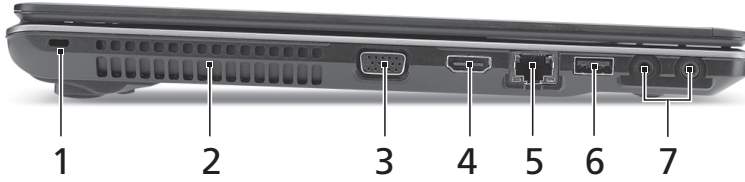

#	Ikon	Objekt	Beskrivning
1		USB 2.0-port	Anslutning för USB 2.0-enheter (t.ex. USB-mus, USB-kamera).
2		Optisk läsenhet	Inbyggd optisk läsenhet för CD- eller DVD-skivor.
3		Åtkomstindikator för optisk läsenhet	Tänds när den optiska läsenheten arbetar.
4		Hål för mekanisk utmatning	Matar ut skivluckan från den optiska läsenheten när datorn är avstängd. <b>Obs!</b> För in spetsen på ett gem i det mekaniska utmatningshålet för att mata ut det optiska enhetsfacket när datorn är avslagen.
5		DC in-anslutning	Ansluts till en växelströmsadapter.





## Vy från vänster

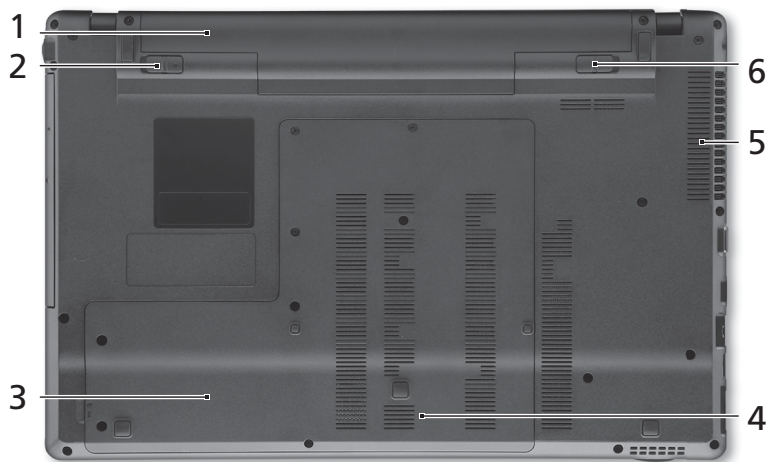

#	Ikön	Objekt	Beskrivning
1		Skåra för Kensingtonlås	Ansluts till ett Kensington-kompatibelt datorskyddslås.
2		Ventilationsöppningar	Möjliggör att datorn håller sig sval, även efter långvarig användning.
3		Port för extern bildskärm (VGA)	Anslutning till en visningsenhet (t.ex. extern bildskärm, LCD-projektor).
4		HDMI-port	Har stöd för digitala videoanslutningar av högdefinitionstyp.
5		Ethernet-port (RJ-45)	Ansluts till ett Ethernet 10/100/1000-baserat nätverk.
6		USB 2.0-port	Anslutning för USB 2.0-enheter (t.ex. USB-mus, USB-kamera).
7		Mikrofoningång	Anslutning för externa mikrofoner.
		Utgång för hörlurar/högtalar/linje ut med S/PDIF-stöd	Anslutning för externa ljudenheter (t.ex. högtalare, hörlurar).

## Vy underifrån



#	Ikon	Objekt	Beskrivning
1		Batterifack	Avsett för datorns batteripack.
2		Batterilås	Låser batteriet på plats.
3		Hårddiskfack	Utrymme för datorns hårddisk (fastskruvad).
4		Minnesfack	Här finns datorns huvudminne.
5		Ventilationsöppningar och kylfläkt	Möjliggör att datorn håller sig sval, även efter långvarig användning. <b>Obs!</b> Täck eller blockera aldrig öppningen till fläkten.
6		Hake för frigöring av batteriet	Frigör batteriet före borttagning.

## Miljö

---

- Temperatur:
    - Vid drift: 5°C till 35°C
    - Utom drift: -20°C till 65°C
  - Luftfuktighet (icke-kondenserande):
    - Vid drift: 20% till 80%
    - Utom drift: 20% till 80%
- 



.....

**Obs!** Specifikationerna som anges ovan är endast avsedda i referenssyfte. Den exakta konfigurationen i din dator beror på vilken modell du har köpt.

Aspire 5745/5553 -sarja

Pikaohje

© 2010 Kaikki oikeudet pidätetään.

Aspire 5745/5553 -sarjan Pikaohje  
Ensimmäinen julkistus: 03/2010

Aspire 5745/5553 -sarjan Kannettava tietokone

Mallinumero: \_\_\_\_\_

Sarjanumero: \_\_\_\_\_

Ostopäivämäärä: \_\_\_\_\_

Ostopaikka: \_\_\_\_\_



# Aloitetaan perusasioista

Haluamme kiittää sinua Acerin kannettavan tietokoneen valitsemisesta liikkuvien tietokonetarpeitesi täyttämässä.

## Ohjeet

Helpottaaksesi sinua Acer-tietokoneen käyttämisessä olemme suunnitelleet sarjan ohjekirjoja:

Ensiksikin, juliste **Aloittelijoille...** auttaa sinua tietokoneen käyttöönotossa.

**Aspire-sarjan Peruskäyttäjän opas** sisältää hyödyllisiä tietoja, jotka käyvät Aspire -tuotesarjan kaikille malleille. Se kattaa perusaiheet kuten joka käyttää näppäistöä, ääntä, jne. On ymmärrettävä, että luonteestaan johtuen, **Peruskäyttäjän opas** sekä alla mainittu **AcerSystem User Guide** viittaavat ajoittain toimintoihin tai ominaisuuksiin, jotka on sisällytetty vain tiettyihin sarjan malleihin, mutta ei välttämättä ostamaasi malliin. Sellaiset tapaukset on merkitty tekstissä kyseisellä kielellä "vain tietyille malleille".

**Pikaohje** esittelee uuden tietokoneesi perusominaisuudet ja -toiminnot. Lisätietoja siitä, miten tietokoneesi auttaa sinua lisäämään tuottavuutta, on annettu ohjeessa **AcerSystem User Guide**. Tässä ohjeessa on yksityiskohtaiset ohjeet järjestelmätoiminnoista, tietojen palauttamisesta, tietokoneen laajentamisesta ja ongelmanratkaisusta. Siinä on myös annettu yleisiä ohjeita, tietoja takuusta sekä turvallisuusohjeita. Se on saatavana Portable Document Format (PDF) -muodossa ja se on jo asennettu tietokoneellesi. Voit avata sen noudattamalla seuraavia ohjeita:

- 1 Napsauta  **Käynnistä > Kaikki ohjelmat > AcerSystem.**
- 2 Napsauta **AcerSystem User Guide.**



-----

**Ohje:** Jotta voit katsella käyttöohjekirjaa, Adobe Readerin on oltava asennettu. Jos Adobe Reader ei ole asennettu, sen asennus käynnistyy ennen **AcerSystem User Guide** avaamista. Noudata näytölle tulevia ohjeita, kunnes asennus on valmis. Saat lisätietoja Adobe Readerin asennuksesta ja käytöstä valikosta **Ohje ja tukikeskus**.

# Tutustuminen Acerin kannettavaan tietokoneeseen

Kun olet asentanut tietokoneesi kuten julisteessa on kuvattu, anna meidän esitellä uusi kannettava Acer-tietokoneesi.

## Näkymä ylhäältä

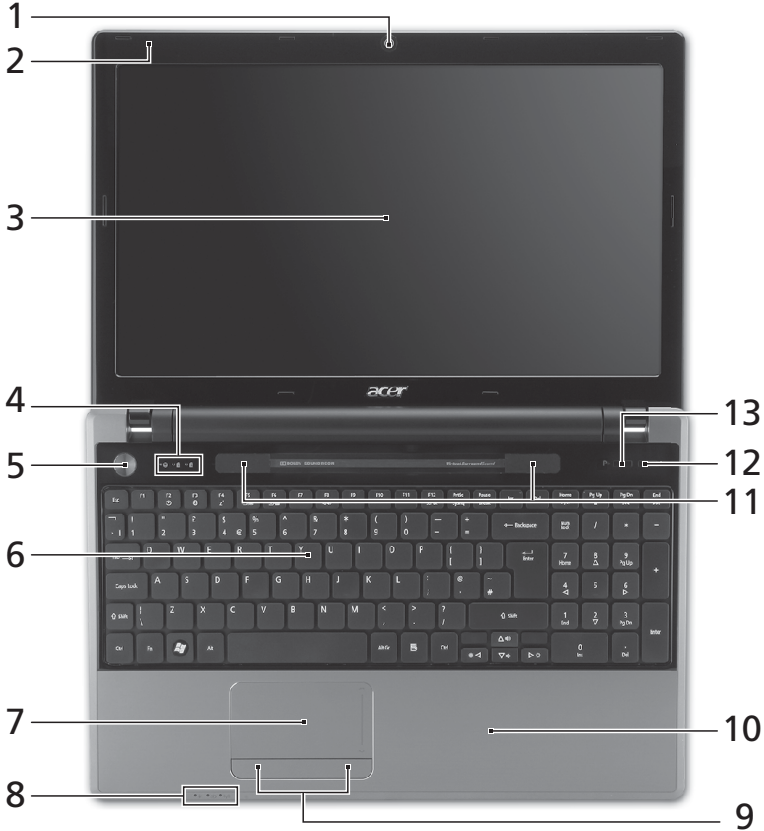

#	Kuvake	Osio	Kuvaus
1		Acer Crystal Eye - webkamera	Web-kamera video-tietoliikenteeseen (vain tietyille malleille).

#	Kuvake	Osio	Kuvaus
2		Mikrofoni	Sisäinen mikrofoni äänen tallentamista varten.
3		Näyttöruutu	Nimeltään myös nestekidenäyttö (Liquid-Crystal Display; LCD), näyttää tietokoneen ulostulon (konfiguraatio voi vaihdella malleista riippuen).
4		HDD-ilmaisain	Palaa, kun kiintolevy on aktiivinen.
		Num Lock - ilmaisain	Syttyy, kun Num Lock on aktivoituneena.
		Caps Lock - ilmaisain	Syttyy, kun Caps Lock on aktivoituneena.
5		Virtapainike	Käynnistää ja sulkee koneen.
6		Näppäimistö	Tiedon syöttämiseen tietokoneelle.
7		Kosketusalusta	Kosketusherkkä osoitinlaite, joka toimii kuten tietokoneen hiiri.
8		Virranilmaisain <sup>1</sup>	Osoittaa tietokoneen virran tilan.
		Akkutilan ilmaisain <sup>1</sup>	Osoittaa tietokoneen akun tilan. <b>1. Lataus meneillään:</b> Valo palaa oranssina, kun akku latautuu. <b>2. Täyteen ladattu:</b> Valo palaa sinisenä, kun tietokone toimii verkkovirralla.
		Kommunikaation ilmaisain <sup>1</sup>	Osoittaa tietokoneen langattoman yhdistettävyyden tilan.
9		Napsauta painikkeita (vasen ja oikea)	Vasen ja oikea painike toimivat kuten hiiren vasen ja oikea painike.
10		Rannetuki	Mukava tuki käsillesi konetta käyttäessäsi.
11		Kaiuttimet	Vasen ja oikea kaiutin tuottavat stereoääntä.
12		Optisen aseman ulostyöntöpainike	Työntää optisen levykkeen ulos asemasta.
13		Ohjelmoitava näppäin	Käyttäjän ohjelmoitavissa (vain tietyille malleille).
		PowerSmart-näppäin	Laittaa tietokoneesi virransäästötilaan (vain valituille malleille).

1. Etupaneelin tilailmaisimet näkyvät, vaikka tietokoneen kansi olisi suljettu.

## Pikavalintanäppäimet

Tietokoneessa on pikavalintanäppäimet tai näppäinyhdistelmät sen useimpia säätöjä, kuten näyttöruudun kirkkautta, äänenvoimakkuutta varten.

Aktivoidaksesi pikavalintanäppäimet paina ja pidä painettuna **<Fn>** -näppäintä ja paina sitten pikavalintanäppäinyhdistelmän toista näppäintä.

Pikanäppäin	Kuvake	Toiminto	Kuvaus
<b>&lt;Fn&gt; + &lt;F3&gt;</b>		Tietoliikennenäppäin	Ottaa käyttöön/poistaa käytöstä tietokoneen tietoliikennelaitteet (Tietoliikennelaitteet voivat vaihdella konfiguroinnilla).
<b>&lt;Fn&gt; + &lt;F4&gt;</b>		Lepotila	Siirtää tietokoneen lepotilaan.
<b>&lt;Fn&gt; + &lt;F5&gt;</b>		Näytön vaihto	Kytkee näytön ulostulon näyttöruudun, ulkoisen monitorin (jos kytketty) ja molempien välillä.
<b>&lt;Fn&gt; + &lt;F6&gt;</b>		Näyttö pois	Sammuttaa näytön taustavalon virran säästämiseksi. Paina mitä tahansa näppäintä palataksesi normaalitilaan.
<b>&lt;Fn&gt; + &lt;F7&gt;</b>		Kosketusalustan vaihtokytkin	Kytkee kosketusalustan käyttöön ja pois käytöstä.
<b>&lt;Fn&gt; + &lt;F8&gt;</b>		Kaiuttimien vaihtokytkin	Kytkee kaiuttimet käyttöön ja pois käytöstä.
<b>&lt;Fn&gt; + &lt;D&gt;</b>		Kirkkauden lisäys	Lisää näytön kirkkautta.
<b>&lt;Fn&gt; + &lt;D&gt;</b>		Kirkkauden vähennys	Vähentää näytön kirkkautta.
<b>&lt;Fn&gt; + &lt;U&gt;</b>		Äänenvoimakkuus ylös	Lisää äänenvoimakkuutta.
<b>&lt;Fn&gt; + &lt;V&gt;</b>		Äänenvoimakkuus alas	Vähentää äänenvoimakkuutta.
<b>&lt;Fn&gt; + &lt;Koti&gt;</b>		Toista/Tauko	Toista tai pysäytä valittu mediatiedosto.
<b>&lt;Fn&gt; + &lt;Sivu ylös&gt;</b>		Pysäytä	Pysäytä valitun mediatiedoston toistaminen.
<b>&lt;Fn&gt; + &lt;Sivu alas&gt;</b>		Edellinen	Palaa edelliseen mediatiedostoon.
<b>&lt;Fn&gt; + &lt;Loppu&gt;</b>		Seuraava	Hyppää seuraavaan mediatiedostoon.



## Etunäkymä suljettuna



#	Kuvake	Osio	Kuvaus
1		Monta yhdessä - kortinlukija	Hyväksyy seuraavat muistikortit: Secure Digital (SD), MultiMediaCard (MMC), Memory Stick (MS), Memory Stick PRO (MS PRO) ja xD-Picture Card (xD). <b>Huomautus:</b> Poista/Asenna kortti työntämällä. Vain yksi kortti voi toimia mihin aikaan hyvänsä.

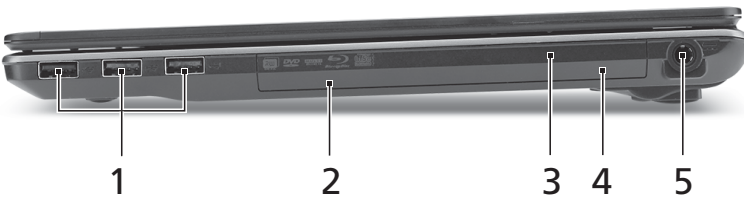





## Oikea näkymä

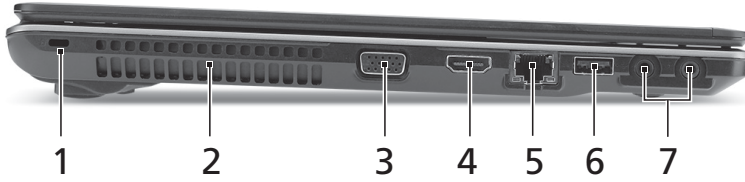

#	Kuvake	Osio	Kuvaus
1		USB 2.0 -portti	Yhdistää USB 2.0 -laitteisiin (esim. USB-hiiri, USB-kamera).
2		Optinen asema	Sisäinen optinen levyasema, hyväksyy CD:t ja DVD:t.
3		Optisen levyn tilan osoitin	Syttyy, kun optinen asema on aktiivinen.
4		Hätäulostyöntöaukko	Työntää ulos optisen aseman kelkan, kun tietokone on sammutettu. <b>Huomautus:</b> Pane paperiliitin hätäpoistoreikään optisen aseman tarjottimen poistamiseksi asemasta, kun tietokone on pois päältä.
5		DC-tulolinja	Yhdistää AC-sovittimeen.





## Vasen näkymä

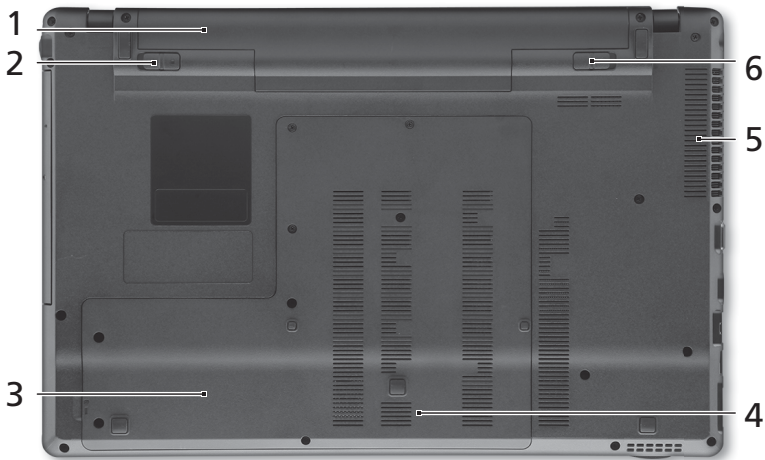

#	Kuvake	Osio	Kuvaus
1		Kensington-lukon paikka	Yhdistää Kensington-yhteensopivaan tietokoneen turvalukkoon.
2		Tuuletuspaikat	Mahdollistaa tietokoneen pysymisen viileänä jopa pitkitetyn käytön jälkeen.
3		Ulkoisen näyttöportti (VGA)	Yhdistää näyttölaitteeseen (esim. ulkoinen monitori, LCD-projektori).
4		HDMI-portti	Tukee korkealaatuisia digitaalisia videoliitäntöjä.
5		Ethernet (RJ-45)-portti	Yhdistää Ethernet 10/100/1000 -pohjaiseen verkkoon.
6		USB 2.0 -portti	Yhdistää USB 2.0 -laitteisiin (esim. USB-hiiri, USB-kamera).
7		Mikrofoni-jakki	Hyväksyy syötteen ulkoisilta mikrofoneilta.
		Kuulokkeet/ kaiutin/line-out - jakkiliitin S/PDIF-tuella	Yhdistää audioliitäntälaitteisiin (esim. kaiuttimet, kuulokkeet).

## Pohjanäkymä



#	Kuvake	Osio	Kuvaus
1		Akkutila	Sisältää tietokoneen akkuyksikön.
2		Akun lukko	Lukitsee akun paikoilleen.
3		Kovalevytila	Sisältää koneen kovalevyn (varmistettu ruuveilla).
4		Muistilokero	Sisältää tietokoneen päämuisti.
5		Tuuletusaukot ja jäähdytystuuletin	Mahdollistaa tietokoneen pysymisen viileänä jopa pitkitetyn käytön jälkeen. <b>Huomautus:</b> Älä peitä tai tuki tuulettimen aukkoa.
6		Akun vapautussalpa	Vapauttaa akun poistamista varten.

## Ympäristö

---

- Lämpötila:
    - Käyttö: 5°C:sta 35°C:een
    - Ei käytössä: -20°C:sta 65°C:een
  - Kosteus (ei kondensoitunut):
    - Käyttö: 20%:sta 80%:een
    - Ei käytössä: 20%:sta 80%:een
- 



.....

**Huomautus:** Yllä luetellut määrittelyt ovat vain viitteellisiä.  
PC:n tarkka konfigurointi riippuu ostetusta mallista.



# Серия *Aspire* 5745/5553

Краткое руководство

© 2010 Все права сохранены.

Краткое руководство по компьютеру серии Aspire 5745/5553  
Первый выпуск: 03/2010

Портативный компьютер серии Aspire 5745/5553

Номер модели: \_\_\_\_\_

Серийный номер: \_\_\_\_\_

Дата покупки: \_\_\_\_\_

Место покупки: \_\_\_\_\_

# Вначале о главном

Благодарим вас за то, что для решения своих мобильных вычислительных задач вы выбрали ноутбук Acer.

## Ваши руководства

Мы разработали ряд руководств, которые помогут вам в использовании ноутбука Acer:

Прежде всего, плакат **Для начинающих...** поможет Вам познакомиться с тем, как настраивать компьютер.

**Типовое руководство пользователя для серии Aspire** содержит полезную информацию, применимую ко всем моделям серии Aspire. В нем описываются основные темы, такие как работа с клавиатурой, звуком и т.д. Пожалуйста, имейте в виду, что **Типовое руководство пользователя** и упомянутое ниже **AcerSystem User Guide** являются обобщенными, поэтому в них иногда будут описываться функции или свойства, реализованные не в купленной вами модели, а лишь в определенных моделях этой серии. В таких случаях в тексте имеется пометка "только для определенных моделей".

**Краткое руководство** в виде знакомит вас с основными характеристиками и функциями вашего нового компьютера. Чтобы узнать больше о том, как повысить продуктивность вашей работы с помощью компьютера, вы можете обратиться к **AcerSystem User Guide**. Это руководство содержит подробную информацию о системных функциях, восстановлении данных, возможностях расширения и устранении неисправностей. Кроме того, оно содержит гарантийную информацию, а также общие предписания и правила безопасности при работе с вашим ноутбуком. Руководство поставляется вместе с компьютером, предварительно загруженное в него в формате PDF. Чтобы обратиться к нему, вам надо сделать следующее:

- 1 Щелкните кнопку  **Пуск > Все программы > AcerSystem**.
- 2 Щелкните **AcerSystem User Guide**.



.....

**Примечание:** Для просмотр файла необходимо установить программу Adobe Acrobat Reader. Если программа Adobe Acrobat Reader не установлена на Вашем компьютере, щелчок мышью по **AcerSystem User Guide** запустит сперва установку програмы Acrobat Reader. Следуйте инструкциям на экране, чтобы завершить процесс установки. За инструкциями о том, как пользоваться программой Adobe Acrobat Reader, обратитесь к меню **Справка и поддержка**.

# Знакомство с ноутбуком Acer

Теперь, когда вы выполнили настройки, как показано на плакате, давайте поближе познакомимся с вашим новым ноутбуком Acer.

## Вид сверху

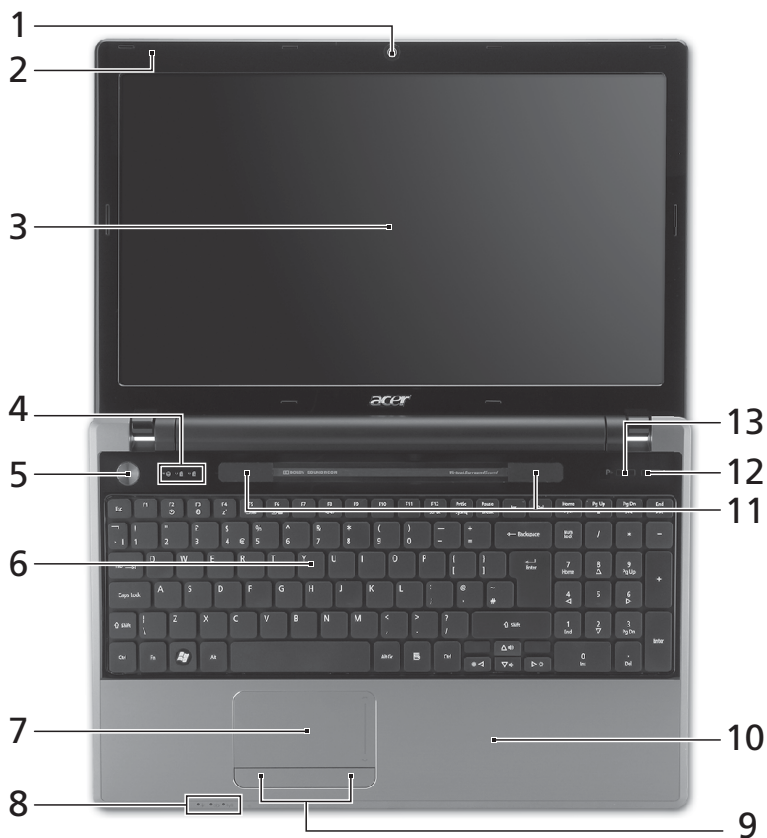

#	Значок	Элемент	Описание
1		Веб-камера Acer Crystal Eye	Веб-камера для видеосвязи (только для определенных моделей).
2		Микрофон	Внутренний микрофон для записи звука.

#	Значок	Элемент	Описание
3		Экран дисплея	Другое название - жидкокристаллический дисплей (ЖК-дисплей); служит для вывода изображения, формируемого компьютером (конфигурация может отличаться в зависимости от модели).
4		Индикатор работы жесткого диска	Горит при обращении к жесткому диску.
		Индикатор режима Num Lock	Загорается при включенной фиксации числового регистра (Num Lock).
		Индикатор режима Caps Lock	Загорается при включенной фиксации верхнего регистра (Caps Lock).
5		Кнопка питания	Служит для включения/выключения компьютера.
6		Клавиатура	Служит для ввода данных в компьютер.
7		Сенсорная панель	Чувствительное к прикосновениям указательное устройство, позволяющее управлять курсором на экране так же, как и мышью.
8		Индикатор питания <sup>1</sup>	Отображает состояние питания компьютера.
		Индикатор аккумулятора <sup>1</sup>	Отображает состояние аккумулятора компьютера. <b>1. Зарядка:</b> этот индикатор горит желтым во время зарядки аккумулятора. <b>2. Полностью заряжен:</b> этот индикатор горит синим при питании от электросети.
		Индикатор связи <sup>1</sup>	Отображает состояние модуля беспроводной связи компьютера.
9		Кнопки управления (левая и правая)	Эти левая и правая кнопки действуют так же, как левая и правая кнопки мыши.
10		Подставка для запястий	Упорная площадка, на которую удобно положить руки при работе на компьютере.
11		Динамики	Левый и правый динамики служат для вывода стереозвuka.
12		Кнопка извлечения диска из привода	Служит для извлечения оптического диска из привода.

#	Значок	Элемент	Описание
13		Программируемая клавиша	Программируется пользователем (только для определенных моделей).
		Клавиша PowerSmart	Перевод компьютера в режим энергосбережения (только для определенных моделей).

1. Индикаторы на передней панели видны даже при закрытой крышке компьютера.

## Клавишные комбинации

В компьютере используются "горячие" клавиши (комбинации клавиш) для быстрого вызова большинства функций управления компьютером, таких как яркость экрана и громкость.

Для использования клавишной комбинации сначала нажмите клавишу **<Fn>** и затем, не отпуская ее, нажмите вторую клавишу этой комбинации.

Клавишная комбинация	Значок	Назначение	Описание
<b>&lt;Fn&gt; + &lt;F3&gt;</b>		Клавиша "Связь"	Включение/выключение модулей связи в компьютере (Тип модуля связи зависит от конфигурации системы).
<b>&lt;Fn&gt; + &lt;F4&gt;</b>		Режим сна	Переводит компьютер в режим Сон.
<b>&lt;Fn&gt; + &lt;F5&gt;</b>		Переключение видеовыхода	Переключает вывод изображения либо на дисплей, либо на внешний монитор (если он подключен), либо одновременно и на дисплей, и на внешний монитор.
<b>&lt;Fn&gt; + &lt;F6&gt;</b>		Выкл. дисплей	Выключает экран дисплея для экономии заряда аккумулятора. Для включения экрана нажмите любую клавишу.
<b>&lt;Fn&gt; + &lt;F7&gt;</b>		Переключатель сенсорной панели	Включает и выключает встроенную сенсорную панель.
<b>&lt;Fn&gt; + &lt;F8&gt;</b>		Выключатель динамиков	Попеременно включает и выключает динамики.
<b>&lt;Fn&gt; + &lt;D&gt;</b>		Повышение яркости	Повышает яркость экрана.

Клавишная комбинация	Значок	Назначение	Описание
<Fn> + <◀>		Понижение яркости	Уменьшает яркость экрана.
<Fn> + <▲>		Увеличение громкости	Повышает громкость звука.
<Fn> + <▼>		Уменьшение громкости	Уменьшает громкость звука.
<Fn> + <Дом>		Воспроизвести/ Приостановить	Воспроизведение или приостановка воспроизведения выбранного медиафайла.
<Fn> + <Pg Up>		Остановить	Останов воспроизведения выбранного медиафайла.
<Fn> + <Pg Dn>		Пред.	Возврат к предыдущему медиафайлу.
<Fn> + <End>		Далее	Переход к следующему медиафайлу.



## Вид спереди с закрытой крышкой



#	Значок	Элемент	Описание
1		Комбинированное устройство считывания карт памяти различных форматов	Поддерживает форматы Secure Digital (SD), MultiMediaCard (MMC), Memory Stick (MS), Memory Stick PRO (MS PRO) и xD-Picture Card (xD). <b>Примечание:</b> надавите, чтобы извлечь/вставить карту. Одновременно можно использовать только одну карту памяти.

## Вид справа







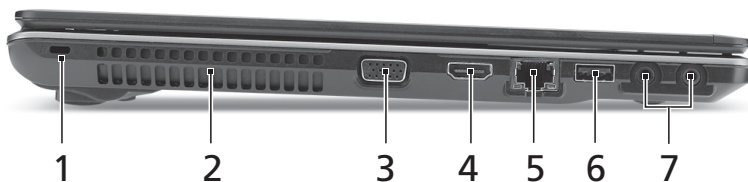

#	Значок	Элемент	Описание
1		Разъем USB 2.0	Служит для подключения устройств с интерфейсом USB 2.0 (например, мыши или камеры).
2		Привод оптических дисков	Внутренний привод оптических дисков рассчитан на использование компакт-дисков или DVD-дисков.
3		Индикатор обращения к оптическому диску	Горит во время работы привода оптических дисков.
4		Отверстие аварийного извлечения	Служит для открытия лотка привода оптических дисков, когда питание компьютера отключено. <b>Примечание:</b> чтобы открыть лоток привода оптических дисков, когда компьютер выключен, вставьте скрепку в это отверстие аварийного извлечения.
5		Разъем для подключения питания постоянного тока	Служит для подключения адаптера переменного тока.







## Вид слева

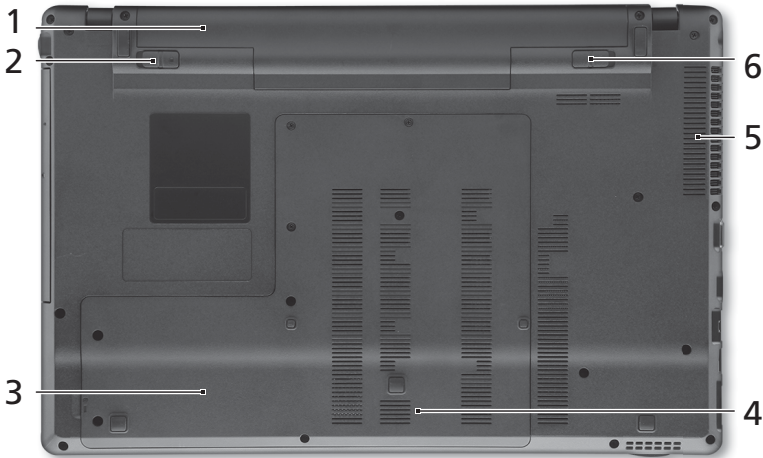

#	Значок	Элемент	Описание
1		Замок типа Kensington	Служит для подсоединения защитного тросика с замком типа Kensington для предотвращения кражи компьютера.
2		Вентиляционные отверстия	Позволяют компьютеру не перегреваться даже при длительной работе.
3		Разъем внешнего дисплея (VGA)	Служит для подключения устройства отображения (например, внешнего монитора, ЖК-проектора).
4		Разъем HDMI	Служит для подключения к источникам цифрового видео высокой четкости.
5		Разъем Ethernet (RJ-45)	Служит для подключения к сети Ethernet 10/100/1000 Мбит/с.
6		Разъем USB 2.0	Служит для подключения устройств с интерфейсом USB 2.0 (например, мыши или камеры).
7		Гнездо микрофона	Служит для подключения внешнего микрофона.
		Гнездо наушников/динамика/линейный выход с поддержкой цифрового интерфейса S/PDIF	Служит для подключения звуковых устройств к линейному выходу (например, динамиков, наушников).

## Вид снизу



#	Значок	Элемент	Описание
1		Отсек аккумулятора	В этот отсек устанавливается аккумулятор компьютера.
2		Защелка аккумулятора	Служит для фиксации аккумулятора в отсеке.
3		Отсек жесткого диска	Служит для установки жесткого диска компьютера (крепление винтами).
4		Отсек модулей оперативной памяти	В этот отсек устанавливаются модули оперативной памяти компьютера.
5		Вентиляционные отверстия и вентилятор охлаждения	Позволяют компьютеру не перегреваться даже при длительной работе. <b>Примечание:</b> не закрывайте и не загромождайте входное отверстие вентилятора.
6		Защелка извлечения аккумулятора	Разблокирует аккумулятор для его извлечения.

## Условия эксплуатации

---

- Температура:
    - Рабочая: от 5°C до 35°C
    - Нерабочая: от -20°C до 65°C
  - Влажность (без конденсации):
    - Рабочая: от 20% до 80%
    - Нерабочая: от 20% до 80%
- 



.....

**Примечание:** перечисленные выше технические характеристики приведены только для справки. Фактическая конфигурация ПК зависит от купленной вами модели.



# Komputer serii Aspire 5745/5553

Skrócony poradnik

© 2010 Wszelkie prawa zastrzeżone.

Skrócony poradnik komputera serii Aspire 5745/5553

Wydanie oryginalne: 03/2010

Notebook PC serii Aspire 5745/5553

Oznaczenie modelu: \_\_\_\_\_

Numer seryjny: \_\_\_\_\_

Data zakupu: \_\_\_\_\_

Miejsce zakupu: \_\_\_\_\_

# Na początek

Dziękujemy za wybranie notebooka PC serii Acer dla celów realizacji potrzeb w zakresie mobilnego przetwarzania.

## Instrukcje

Aby pomóc w korzystaniu z komputera Acer, opracowaliśmy zestaw instrukcji:

Jako pierwszy można wymienić poster **Dla początkujących...**, który pomoże użytkownikom rozpocząć ustawianie komputera.

**Ogólne podręcznika użytkownika urządzenia serii Aspire** zawiera przydatne informacje dotyczące wszystkich modeli serii Aspire. Obejmuje podstawowe zagadnienia, takie jak używanie klawiatury, dźwięki itd. Należy pamiętać, że **Ogólny podręcznik użytkownika** oraz **AcerSystem User Guide**, o którym mowa poniżej, odnoszą się czasami do funkcji lub elementów tylko niektórych modeli serii, które nie muszą występować w zakupionym modelu. W takich przypadkach użyto oznaczenia „tylko w niektórych modelach”.

**Skrócony poradnik** przedstawia podstawowe właściwości i funkcje nowego komputera. Aby uzyskać więcej informacji o tym, w jaki sposób nowy komputer może pomóc Ci być bardziej produktywnym, zapoznaj się z **AcerSystem User Guide**. Przewodnik ten zawiera szczegółowe informacje dotyczące takich tematów, jak narzędzia systemowe, odzyskiwanie danych, opcje rozszerzeń oraz rozwiązywanie problemów. Oprócz nich, zawiera także informacje na temat gwarancji oraz informacje dotyczące bezpieczeństwa pracy z komputerem przenośnym. Jest on dostępny w formie elektronicznej jako dokument w formacie Portable Document Format (PDF) i jest dostarczany jako zapisany w Twoim notebooku. Wykonaj poniższe czynności, aby uzyskać do niego dostęp:

- 1 Kliknij  **Start > Wszystkie programy > AcerSystem**.
- 2 Kliknij **AcerSystem User Guide**.



.....

**Uwaga:** Aby można było przeglądać ten plik, konieczne jest zainstalowanie programu Adobe Reader. Jeżeli w komputerze nie zainstalowano programu Adobe Reader, kliknięcie **AcerSystem User Guide** spowoduje uruchomienie instalatora programu Adobe Reader. W celu dokończenia instalacji należy wykonać instrukcje wyświetlane na ekranie. Instrukcje dotyczące używania programu Adobe Reader, znajdują się w menu **Pomocy i obsługi technicznej**.

# Zapoznanie z notebookiem Acer

Po ustawieniu komputera jak to przedstawiono na ilustracji w posterze, przyjrzyjmy się nowemu notebookowi Acer.

## Widok z góry

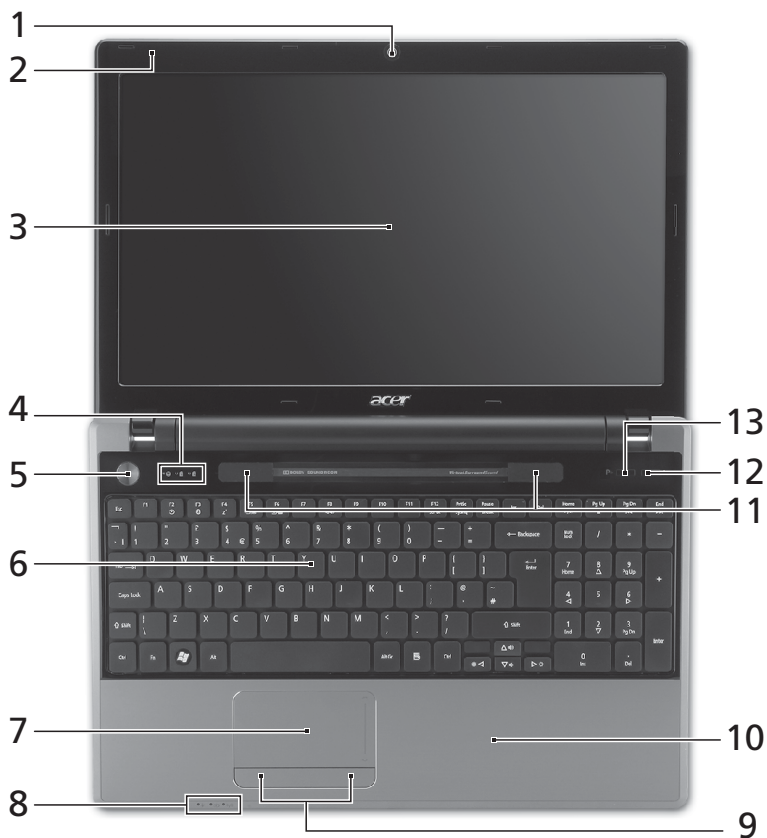

#	Ikona	Element	Opis
1		Kamera Acer Crystal Eye	Kamera internetowa do komunikacji wideo (tylko w niektórych modelach).
2		Mikrofon	Wewnętrzny mikrofon do rejestracji dźwięku.



#	Ikona	Element	Opis
3		Ekran wyświetlacza	Nazywany jest także wyświetlaczem ciekłokrystalicznym (Liquid-Crystal Display; LCD), wyświetla informacje wyjściowe komputera (konfiguracja może być różna w zależności od modelu).
4		Wskaźnik dysku twardego	Świeci, gdy działa dysk twardy.
		Wskaźnik Num Lock	Świeci po uaktywnieniu klawisza NumLk.
		Wskaźnik Caps Lock	Świeci po uaktywnieniu klawisza Caps Lock.
5		Przycisk zasilania	Służy do włączania i wyłączania komputera.
6		Klawiatura	Umożliwia wprowadzanie danych do komputera.
7		Touchpad	Dotykowe urządzenie wskazujące, które działa jak myszka komputerowa.
8		Wskaźnik zasilania <sup>1</sup>	Wskazuje stan zasilania komputera.
		Wskaźnik akumulatora <sup>1</sup>	Wskazuje stan akumulatora komputera. <b>1. Ładowanie:</b> Świeci żółtym światłem, gdy akumulator jest ładowany. <b>2. Pełne naładowanie:</b> Świeci niebieskim światłem podczas pracy w trybie zasilania prądem przemiennym.
		Wskaźnik komunikacji <sup>1</sup>	Wskazuje stan połączenia bezprzewodowego komputera z urządzeniem.
9		Przyciski kliknięć (lewy i prawy)	Działanie lewego i prawego przycisku jest podobne do działania lewego i prawego przycisku myszki.
10		Podparcie nadgarstków	Wygodne podparcie dłoni podczas używania komputera.
11		Głośniki	Lewy i prawy głośnik zapewniają możliwość słuchania stereofonicznego dźwięku.
12		Przycisk wysuwania napędu optycznego	Wyrzuca dysk optyczny z napędu.









#	Ikona	Element	Opis
13		Klawisz programowalny	Programowalny przez użytkownika (tylko w niektórych modelach).
		Przycisk PowerSmart	Przełącza komputer na tryb oszczędności energii (tylko w niektórych modelach).







1. Wskaźniki panelu czołowego są widoczne nawet po zamknięciu pokrywy komputera.

## Klawisze skrótów

Komputer umożliwia używanie klawiszy skrótów lub kombinacji klawiszy w celu uzyskania dostępu do większości kontrolowanych parametrów, takich jak jasność ekranu czy ustawienia głośności.





Aby uaktywnić klawisze skrótów, naciśnij i przytrzymaj klawisz **<Fn>** przed naciśnięciem innego klawisza w kombinacji klawisza skrótu.

Klawisz skrótu	Ikona	Funkcja	Opis
<b>&lt;Fn&gt; + &lt;F3&gt;</b>		Klawisz komunikacji	Włącza/wyłącza urządzenia komunikacyjne komputera (urządzenia komunikacyjne mogą być różne w zależności od konfiguracji).
<b>&lt;Fn&gt; + &lt;F4&gt;</b>		Wstrzymanie	Powoduje przejście komputera do trybu Wstrzymanie.
<b>&lt;Fn&gt; + &lt;F5&gt;</b>		Przełączenie wyświetlania	Umożliwia przełączenie sygnału wyjściowego wyświetlacza na ekran wyświetlacza lub na zewnętrzny monitor (jeśli jest przyłączony) lub na oba.
<b>&lt;Fn&gt; + &lt;F6&gt;</b>		Wyłączenie ekranu	Wyłącza podświetlenie ekranu wyświetlacza w celu oszczędzania energii. Naciśnij dowolny klawisz w celu przywrócenia wyświetlania.
<b>&lt;Fn&gt; + &lt;F7&gt;</b>		Przełączenie touchpada	Umożliwia włączenie i wyłączenie wewnętrznego touchpada.
<b>&lt;Fn&gt; + &lt;F8&gt;</b>		Przełączenie głośnika	Umożliwia włączenie i wyłączenie głośników.
<b>&lt;Fn&gt; + &lt;D&gt;</b>		Zwiększenie jasności	Zwiększa jasność ekranu.
<b>&lt;Fn&gt; + &lt;D&gt;</b>		Zmniejszenie jasności	Zmniejsza jasność ekranu.

Klawisz skrót	Ikona	Funkcja	Opis
<Fn> + <Δ>		Zwiększenie głośności	Zwiększa głośność dźwięku.
<Fn> + <▽>		Zmniejszenie głośności	Zmniejsza głośność dźwięku.
<Fn> + <Home>		Odtwórz/ Wstrzymaj	Odtwarzanie lub wstrzymanie wybranego pliku multimedialnego.
<Fn> + <Pg Up>		Zatrzymaj	Zatrzymanie odtwarzania wybranego pliku multimedialnego.
<Fn> + <Pg Dn>		Wstecz	Powrót do wcześniejszego pliku multimedialnego.
<Fn> + <End>		Dalej	Przeskoczenie do następnego pliku multimedialnego.



## Zbliżenie z przodu



#	Ikona	Element	Opis
1	   	Wielofunkcyjny czytnik kart pamięci	Obsługuje następujące typy kart: Secure Digital (SD), MultiMediaCard (MMC), Memory Stick (MS), Memory Stick PRO (MS PRO) oraz xD-Picture Card (xD). <b>Uwaga:</b> Aby wyjąć/zainstalować kartę, wciśnij ją delikatnie. Jednorazowo można obsługiwać tylko jedną kartę.

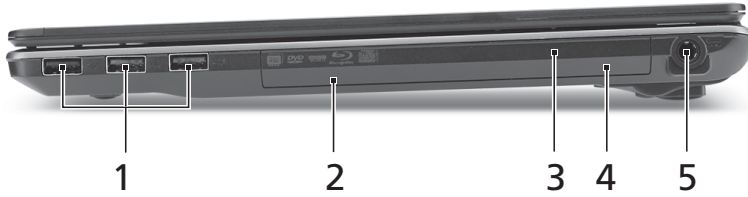





## Widok z prawej

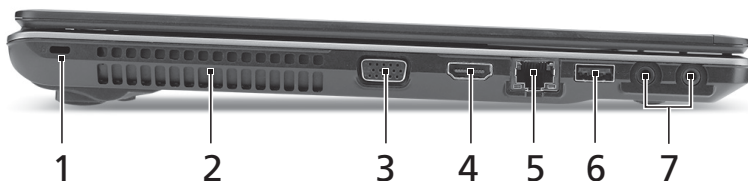

#	Ikona	Element	Opis
1		Port USB 2.0	Służy do przyłączania urządzeń USB 2.0 (np. myszka USB, aparat cyfrowy USB).
2		Napęd optyczny	Wewnętrzny napęd optyczny; obsługuje dyski CD lub DVD.
3		Wskaźnik dostępu do dysku optycznego	Świeci, kiedy napęd optyczny jest aktywny.
4		Otwór wysuwania awaryjnego	Umożliwia wysunięcie tacy napędu optycznego, kiedy komputer jest wyłączony. <b>Uwaga:</b> Wsuń spinacz do otworu wysuwania awaryjnego w celu wysunięcia tacy napędu optycznego, kiedy komputer jest wyłączony.
5		Gniazdo zasilania	Gniazdo zasilacza.





## Widok z lewej strony

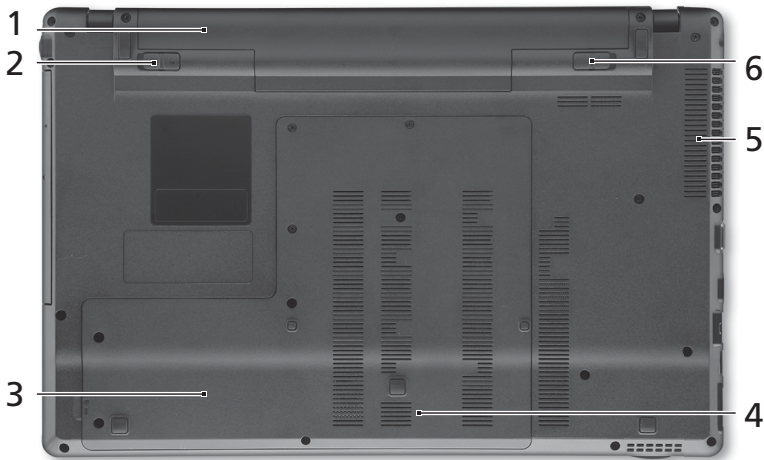

#	Ikona	Element	Opis
1		Gniazdo blokady Kensington	Służy do podłączenia blokady zgodnej ze standardem firmy Kensington.
2		Szczeliny wentylacyjne	Umożliwiają chłodzenie komputera nawet podczas długotrwałego użytkowania.
3		Port zewnętrznego wyświetlacza (VGA)	Służy do przyłączenia urządzenia wyświetlającego (np. zewnętrzny monitor, projektor LCD).
4		Port HDMI	Obsługuje połączenia cyfrowego wideo o wysokiej rozdzielczości.
5		Port Ethernet (RJ-45)	Służy do przyłączenia do sieci komputerowej typu Ethernet 10/100/1000.
6		Port USB 2.0	Służy do przyłączenia urządzeń USB 2.0 (np. myszka USB, aparat cyfrowy USB).
7		Gniazdo mikrofonowe	Służy do przyłączenia sygnału z zewnętrznych mikrofonów.
		Gniazdo słuchawkowe/ głośnikowe/ wyjścia liniowego z obsługą S/PDIF	Służy do przyłączenia urządzeń liniowego wyjścia audio (np. głośniki, słuchawki).

## Widok od strony podstawy



#	Ikona	Element	Opis
1		Wnęka na baterię	Przechowuje baterię komputera.
2		Zatrzaszk baterii	Pozwala zabezpieczyć baterię w prawidłowej pozycji.
3		Wnęka na dysk twardy	Mieści dysk twardy komputera (zabezpieczona śrubami).
4		Przegroda na pamięć	Mieści główną pamięć komputera.
5		Otwory wentylacyjne oraz wentylator	Umożliwiają chłodzenie komputera nawet podczas długotrwałego użytkowania. <b>Uwaga:</b> Nie wolno zakrywać ani blokować otworu wentylatora.
6		Blokada baterii	Umożliwia zwolnienie i wyjęcie baterii.

## Warunki środowiska

---

- Temperatura:
    - Podczas pracy: od 5°C do 35°C
    - Podczas przechowywania: od -20°C do 65°C
  - Wilgotność (bez kondensacji pary):
    - Podczas pracy: od 20% do 80%
    - Podczas przechowywania: od 20% do 80%
- 



.....

**Uwaga:** Powyższe dane techniczne zostały podane tylko w celach informacyjnych. Dokładna konfiguracja komputera PC zależy od zakupionego modelu.





# Aspire 5745/5553 sorozat

Rövid útmutató

© 2010 Minden jog fenntartva.

Aspire 5745/5553 sorozat Rövid útmutató

Eredeti kiadás: 03/2010

Aspire 5745/5553 sorozatú hordozható számítógép

Modellszám: \_\_\_\_\_

Sorozatszám: \_\_\_\_\_

Vásárlás időpontja: \_\_\_\_\_

Vásárlás helye: \_\_\_\_\_

# Az első lépések

Köszönjük, hogy mobil számítástechnikai feladatai elvégzéséhez egy Acer sorozatú hordozható számítógépet választott!

## Útmutatók

Minden segítséget szeretnénk megadni Önnek új Acer gépének használatához, ezért a következő útmutatókat dolgoztuk ki:

Az első a **Kezdők számára...** poszter, amely segítségére lesz a számítógép üzembe helyezésénél.

A **Aspire** sorozat elérhető **Általános felhasználói útmutató** a Aspire terméksorozat összes tagjára vonatkozó hasznos tudnivalókat tartalmaz. Olyan általános témaköröket tárgyal, mint a billentyűzet használata, a hangok stb. Felhívjuk a figyelmét arra, hogy jellegénél fogva az **Általános felhasználói útmutató** és az alábbiakban említett **AcerSystem User Guide** egyes esetekben olyan funkciókra vagy szolgáltatásokra is hivatkozhat, amelyeket csak bizonyos típusok támogatnak, de az Ön által megvásárolt típus esetében nem feltétlenül érhetők el. Az ilyen eseteket a szövegben a „csak bizonyos modellek esetében” vagy hasonló megjegyzés jelöli.

A **Rövid útmutató** ismerteti új számítógépének alapvető jellemzőit és funkciót. A számítógép még hatékonyabb használatával kapcsolatban az **AcerSystem User Guide**. Ez a kézikönyv részletes információkat tartalmaz például az előre telepített segédprogramokról, az adat-helyreállításról, a bővítési lehetőségekről és a hibaelhárításról. Emellett ismerteti a garanciával kapcsolatos tudnivalókat, valamint a számítógépre vonatkozó általános szabályokat és biztonsági előírásokat. A kézikönyv Portable Document Format (PDF) formátumú, és gyárilag telepítve van a számítógépre. Megnyitásához kövesse az alábbi lépéseket:

- 1 Kattintson a következő elemekre:  **Start > Minden program > AcerSystem.**
- 2 Kattintson a következő elemre: **AcerSystem User Guide.**



-----

**Megjegyzés:** A fájl megtekintéséhez szükség van az Adobe Reader alkalmazásra. Ha az Adobe Reader nincs telepítve a számítógépre, akkor az **AcerSystem User Guide** elemre kattintva először az Adobe Reader telepítőprogramja jelenik meg. A telepítés elvégzéséhez kövesse a képernyőn megjelenő utasításokat. Az Adobe Reader használatával kapcsolatban a **Súgó és támogatás** menüben talál útmutatást.







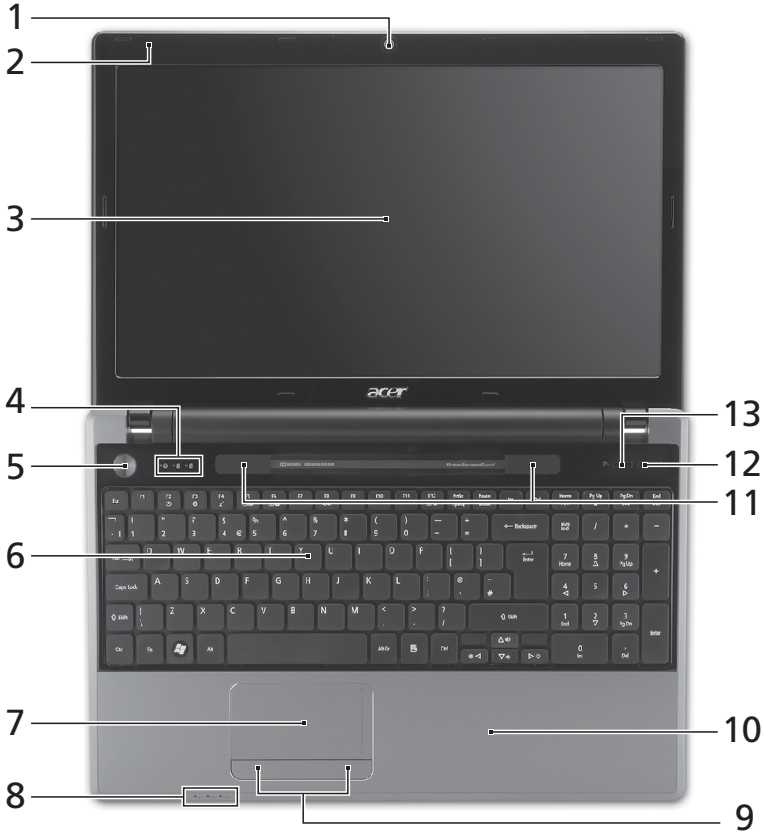

# Ismerkedjen meg új Acer gépével!

Miután a poszter alapján üzembe helyezte a számítógépet, ismerkedjen meg új Acer notebookjával!

## Felülnézet



#	Ikon	Elem	Leírás
1		Acer Crystal Eye webkamera	Webkamera videokommunikációs célokra (csak bizonyos modellek esetében).
2		Mikrofon	Belső mikrofon hangfelvételek készítéséhez.















#	Ikon	Elem	Leírás
3		Kijelző	Más néven folyadékkristályos kijelző (Liquid-Crystal Display, LCD), a számítógép kimenetét jeleníti meg (a konfiguráció típustól függően változhat).
4		Merevlemez jelzőfénye	Jelzi, ha a merevlemez használatban van.
		Num Lock állapotjelző	Akkor világít, ha a Num Lock be van kapcsolva.
		Caps Lock állapotjelző	Akkor világít, ha a Caps Lock be van kapcsolva.
5		Bekapcsoló gomb	A számítógép be- és kikapcsolására szolgál.
6		Billentyűzet	Az adatbevitel eszköze.
7		Érintőpad	Érintésérzékeny mutatóeszköz, a számítógépek egeréhez hasonlóan működik.
8		Üzemállapot jelzőfénye <sup>1</sup>	A számítógép üzemállapotát jelzi.
		Akkumulátor állapotjelzője <sup>1</sup>	Az akkumulátor üzemállapotát jelzi. <b>1. Töltés:</b> Sárgán világít, ha az akkumulátor töltése folyamatban van. <b>2. Teljesen feltöltve:</b> Hálózati tápellátás használatakor kéken világít.
		Kommunikáció jelző <sup>1</sup>	A számítógép vezeték nélküli kommunikációs egységének állapotát jelzi.
9		Kattintógombok (bal és jobb)	A bal és a jobb gomb az egér bal és jobb gombjához hasonlóan működik.
10		Csuklótámasz	Kényelmes támaszkodási felület a számítógép használatának idejére.
11		Hangszórók	A bal és a jobb oldali hangszórók sztereó hangkimenetet biztosítanak.
12		Optikai meghajtó kiadógombja	Kiadatja a lemezt az optikai meghajtóból.
13		Programozható billentyű	Felhasználó által programozható (csak bizonyos modellek esetében).
		PowerSmart gomb	Segítségével energiatakarékos módba állítható a számítógép (csak bizonyos modellek esetében).

1. Az előlap jelzői akkor is láthatók, ha a számítógép fedele le van hajtva.

## Gyorsbillentyűk

A számítógép a legtöbb beállítás elérését gyorsbillentyűkkel vagy billentyűkombinációkkal teszi lehetővé; ilyen például a képernyő fényereje és a hangerő.

Gyorsbillentyű használatához nyomja le és tartsa lenyomva az **<Fn>** billentyűt, a billentyűkombináció másik billentyűjét csak ezt követően nyomja le.

Gyorsbillentyű	Ikon	Funkció	Leírás
<b>&lt;Fn&gt; + &lt;F3&gt;</b>		Kommunikációs billentyű	A számítógép kommunikációs moduljainak be- és kikapcsolására használható (A kommunikációs modulok konfigurációtól függően eltérők lehetnek).
<b>&lt;Fn&gt; + &lt;F4&gt;</b>		Alvás	Alvó üzemmódba helyezi a számítógépet.
<b>&lt;Fn&gt; + &lt;F5&gt;</b>		A kijelző átkapcsolása	Vált a következő megjelenítési módok között: kijelző, külső monitor (ha csatlakoztatva van), illetve mindkettő.
<b>&lt;Fn&gt; + &lt;F6&gt;</b>		A kijelző kikapcsolása	Kikapcsolja a kijelző háttérvilágítását, ezzel energiát takarítva meg. A háttérvilágítás bármely billentyű megnyomására visszakapcsol.
<b>&lt;Fn&gt; + &lt;F7&gt;</b>		Az érintőpad átkapcsolása	Be- és kikapcsolja a beépített érintőpadot.
<b>&lt;Fn&gt; + &lt;F8&gt;</b>		Hangszóró be- és kikapcsolása	Be- és kikapcsolja a hangszórókat.
<b>&lt;Fn&gt; + &lt;▷&gt;</b>		Fényerő növelése	Növeli a kijelző fényerejét.
<b>&lt;Fn&gt; + &lt;◁&gt;</b>		Fényerő csökkentése	Csökkenti a kijelző fényerejét.
<b>&lt;Fn&gt; + &lt;△&gt;</b>		Hangerő növelése	Növeli a hangerőt.
<b>&lt;Fn&gt; + &lt;▽&gt;</b>		Hangerő csökkentése	Csökkenti a hangerőt.
<b>&lt;Fn&gt; + &lt;Home&gt;</b>		Lejátszás/szünet	A kijelölt médiafájl lejátszása vagy lejátszásának szüneteltetése.
<b>&lt;Fn&gt; + &lt;Pg Up&gt;</b>		Leállítás	A kijelölt médiafájl lejátszásának leállítása.
<b>&lt;Fn&gt; + &lt;Pg Dn&gt;</b>		Előző	Visszalépés az előző médiafájltra.
<b>&lt;Fn&gt; + &lt;End&gt;</b>		Tovább	Ugrás a következő médiafájltra.



## Előnézet lehajtott kijelzővel



#	Ikon	Elem	Leírás
1		Multifunkciós kártyaolvasó	Secure Digital (SD), MultiMediaCard (MMC), Memory Stick (MS), Memory Stick PRO (MS PRO) és xD-Picture Card (xD) kártyák fogadására képes. <b>Megjegyzés:</b> A kártyák finoman benyomva helyezhetők be és vehetők ki. Egyszerre csak egyféle kártya használatára van lehetőség.







## Jobb oldali nézet

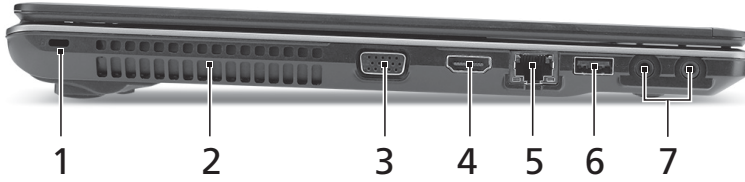

#	Ikon	Elem	Leírás
1		USB 2.0 port	USB 2.0 eszközök (pl. USB-s egér vagy kamera) csatlakoztatását teszi lehetővé.
2		Optikai meghajtó	Belső optikai meghajtó, CD- és DVD-lemezek kezelésére képes.
3		Az optikai lemez elérését jelző fény	Akkor világít, amikor az optikai meghajtó aktív.
4		Vészkiadó furat	Lehetővé teszi az optikai meghajtó tálcájának a számítógép kikapcsolt állapotában történő kinyitását. <b>Megjegyzés:</b> Az optikai meghajtó lemeztálcájának kinyitásához helyezzen egy papírkapcsot a vészkiadó nyílásba, ha a számítógép ki van kapcsolva.
5		Egyenáramú bemeneti aljzat	A váltakozó áramú hálózati adapter csatlakoztatását teszi lehetővé.

## Bal oldali nézet







#	Ikon	Elem	Leírás
1		Kensington záraljzat	Kensington számítógépes biztonsági zár alkalmazását teszi lehetővé.
2		Szellőzőnyílások	Segítségükkel még hosszhasználat esetén is fenntartható a számítógép megfelelő üzemi hőmérséklete.
3		Külső kijelző (VGA) port	Megjelenítő eszköz (pl. külső monitor vagy LCD kivetítő) csatlakoztatását teszi lehetővé.
4		HDMI port	A nagy felbontású, digitális videokapcsolatokat támogatja.
5		Ethernet (RJ-45) port	Ethernet 10/100/1000 típusú hálózattal képes biztosítani a kapcsolatot.
6		USB 2.0 port	USB 2.0 eszközök (pl. USB-s egér vagy kamera) csatlakoztatását teszi lehetővé.
7		Mikrofonaljzat	Külső mikrofon csatlakoztatását teszi lehetővé.
		Fejhallgató/hangszóró/vonali kimenet, S/PDIF-támogatással	Hangkimeneti eszközök (pl. hangszórók, fejhallgató) csatlakoztatását teszi lehetővé.

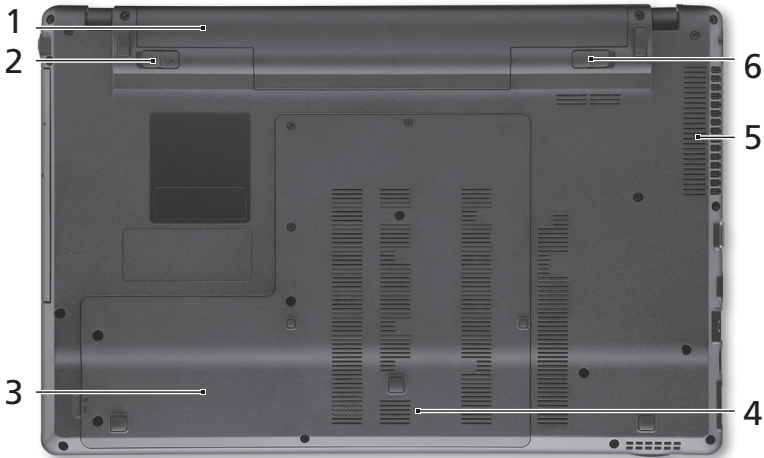

## Alulnézet



#	Ikon	Elem	Leírás
1		Akkumulátorfoglalat	A számítógép akkumulátorát fogadja be.
2		Akkumulátor retesze	Az akkumulátor rögzítését biztosítja.
3		Merevlemez-foglalat	A számítógép merevlemezét fogadja be (csavaros rögzítésű).
4		Memóriarekesz	A számítógép memóriáját fogadja be.
5		Szellőzőnyílások és hűtőventilátor	Segítségükkel még hosszas használat esetén is fenntartható a számítógép megfelelő üzemi hőmérséklete. <b>Megjegyzés:</b> A ventilátor nyílását nem szabad elfedni, illetve a levegő áramlását egyéb módon sem szabad akadályozni.
6		Akkumulátor kioldógombja	Az akkumulátor eltávolítását teszi lehetővé.

## Környezet

---

- Hőmérséklet:
    - Üzemeltetés: 5°C – 35°C
    - Kikapcsolt állapotban: -20°C – 65°C
  - Páratartalom (kicsapódás nélkül):
    - Üzemeltetés: 20% – 80%
    - Kikapcsolt állapotban: 20% – 80%
- 



.....

**Megjegyzés:** A fent megadott specifikációk csak tájékoztató jellegűek. A számítógép pontos konfigurációja a megvásárolt modell függvénye.

# Řada Aspire 5745/5553

Stručné pokyny

© 2010 Všechna práva vyhrazena.

Stručné pokyny pro počítače řady Aspire 5745/5553

Původní vydání: 03/2010

Notebook řady Aspire 5745/5553

Číslo modelu: \_\_\_\_\_

Sériové číslo: \_\_\_\_\_

Datum zakoupení: \_\_\_\_\_

Místo zakoupení: \_\_\_\_\_

# Stručné pokyny

Děkujeme vám, že jste si k uspokojení svých potřeb v oblasti přenosných počítačů vybrali řadu notebooků Acer.

## Uživatelské příručky

Abychom vám při používání notebooku Acer pomohli, vytvořili jsme pro vás sadu příruček:

První leták **První kroky...** vám pomůže při úvodním nastavení počítače.

**Obecná uživatelská příručka pro počítače řady Aspire** obsahuje užitečné informace pro všechny modely řady Aspire. Obsahuje základní témata, např. používání klávesnice, zvuk atd. Berte laskavě na vědomí, že **Obecná uživatelská příručka**, jak již její název předesílá, stejně jako níže zmíněná **AcerSystem User Guide**, může popisovat funkce nebo vlastnosti, kterými jsou vybaveny pouze určité modely dané řady, a kterými nemusí být nutně vybaven vámi zakoupený model. V takových případech je text označen frází „pouze u vybraných modelů“.

**Stručné pokyny** vás seznámí se základními schopnostmi a funkcemi nového počítače. Další informace o tom, jak můžete pomocí počítače zvýšit svou produktivitu, naleznete v příručce **AcerSystem User Guide**. Tato příručka obsahuje podrobné informace týkající se například systémových nástrojů, obnovování dat, možností rozšíření a odstraňování potíží. Dále obsahuje záruční informace, informace týkající se všeobecných předpisů a bezpečnostní upozornění k notebooku. Příručka je k dispozici ve formátu PDF (Portable Document Format) a je již uložena do notebooku. Zobrazíte ji následujícím postupem:

- 1 Klepněte na tlačítko  **Start > Všechny programy > AcerSystem**.
- 2 Klepněte na položku **AcerSystem User Guide**.



.....

**Poznámka:** K zobrazení tohoto souboru je vyžadován program Adobe Reader. Pokud v počítači není program Adobe Reader nainstalován, klepnutím na položku **AcerSystem User Guide** nejprve spustíte instalační program. Dokončete instalaci podle pokynů na obrazovce. Pokyny týkající se používání programu Adobe Reader jsou k dispozici v nabídce **Nápověda a odborná pomoc**.







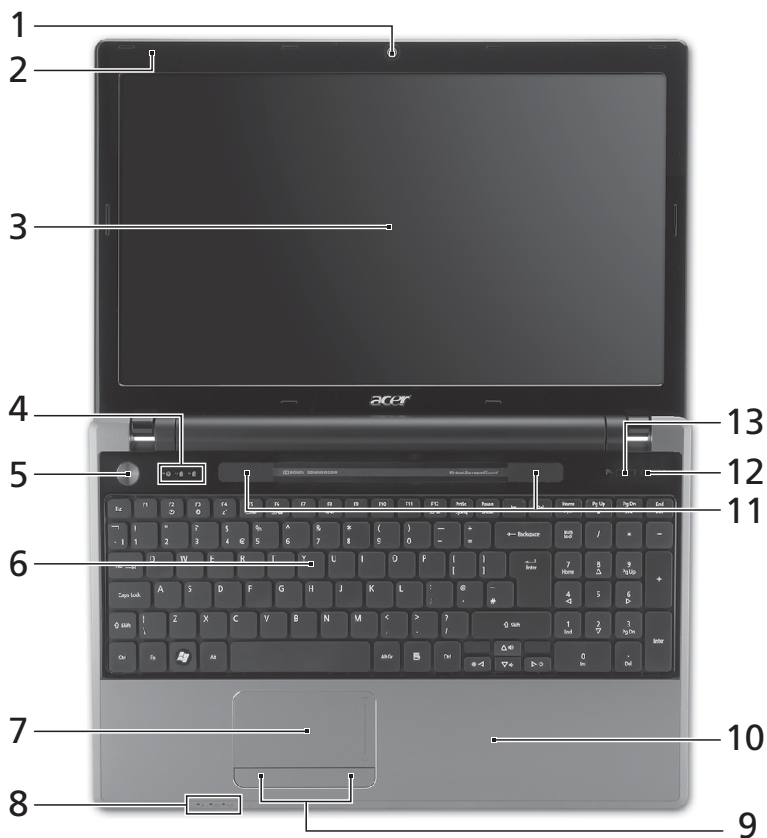

# Seznámení s notebookem Acer

Po nastavení počítače podle pokynů znázorněných na letáku vás seznámíme s vaším novým notebookem Acer.

## Pohled shora



#	Ikona	Položka	Popis
1		Webová kamera Acer Crystal Eye	Webová kamera pro obrazovou komunikaci (pouze u vybraných modelů).
2		Mikrofon	Interní mikrofon pro nahrávání zvuku.















#	Ikona	Položka	Popis
3		Displej	Na displeji, označovaném také displej z tekutých krystalů (Liquid-Crystal Display; LCD), se zobrazuje grafický výstup počítače (Konfigurace se může lišit podle modelů).
4		Indikátor HDD	Svítlí, pokud je aktivní pevný disk.
		Indikátor pro Num Lock	Svítlí při aktivaci funkce NumLk.
		Indikátor pro Caps Lock	Svítlí při aktivaci funkce Caps Lock.
5		Tlačítko napájení	Slouží k zapnutí a vypnutí počítače.
6		Klávesnice	Slouží k zadávání údajů do počítače.
7		Touchpad	Polohovací zařízení citlivé na dotek, které má podobnou funkci jako počítačová myš.
8		Indikátor napájení <sup>1</sup>	Indikuje stav napájení počítače.
		Indikátor baterie <sup>1</sup>	Indikuje stav baterie počítače. <b>1. Nabíjení:</b> Při nabíjení baterie svítí indikátor jantarově. <b>2. Plně nabití:</b> V režimu napájení ze sítě svítí indikátor modře.
		Indikátor komunikace <sup>1</sup>	Indikuje stav zařízení pro bezdrátové připojení počítače.
9		Tlačítka (levé a pravé)	Levé a pravé tlačítko funguje jako levé a pravé tlačítko myši.
10		Podložka ruky	Oblast k pohodlnému opření rukou při používání počítače.
11		Reproduktory	Levý a pravý reproduktor zajišťují stereofonní zvukový výstup.
12		Tlačítko vysunutí optické jednotky	Vysouvá optický disk z jednotky.
13		Programovatelná klávesa	Uživatelsky programovatelná (pouze u vybraných modelů).
		Klávesa PowerSmart	Počítač přejde do úsporného režimu (pouze u vybraných modelů).

1. Stavové indikátory na předním panelu jsou viditelné i po zavření víka počítače.

## Klávesové zkratky

Tento počítač využívá klávesové zkratky nebo kombinace kláves ke zpřístupnění většiny ovládacích prvků počítače, jako je jas zobrazení a hlasitost výstupu.

Klávesovou zkratku aktivujete stisknutím a podržením klávesy <Fn> dříve, než stisknete druhou klávesu této kombinace.

Klávesová zkratka	Ikona	Funkce	Popis
<Fn> + <F3>		Komunikační klávesa	Povoluje/zakazuje komunikační zařízení počítače (Komunikační zařízení mohou mít různou konfiguraci).
<Fn> + <F4>		Režim spánku	Slouží k přepnutí počítače do režimu spánku.
<Fn> + <F5>		Přepnutí displeje	Přepíná výstup zobrazení mezi displejem, externím monitorem (pokud je připojen) a oběma zařízeními.
<Fn> + <F6>		Vypnout displej	Slouží k vypnutí podsvícení obrazovky displeje, čímž se ušetří energie. Podsvícení obnovíte stisknutím libovolné klávesy.
<Fn> + <F7>		Přepnutí zařízení touchpad	Slouží k zapnutí a vypnutí interního zařízení touchpad.
<Fn> + <F8>		Přepnutí reproduktoru	Slouží k zapnutí a vypnutí reproduktorů.
<Fn> + <D>		Zvýšení jasu	Slouží ke zvýšení jasu obrazovky.
<Fn> + <D>		Snížení jasu	Slouží ke snížení jasu obrazovky.
<Fn> + <Δ>		Zvýšení hlasitosti	Slouží ke zvýšení hlasitosti zvuku.
<Fn> + <▽>		Snížení hlasitosti	Slouží ke snížení hlasitosti zvuku.
<Fn> + <Home>		Přehrávat/ Pozastavit	Přehrát nebo pozastavit vybraný mediální soubor.
<Fn> + <Pg Up>		Zastavit	Zastavit přehrávání vybraného mediálního souboru.
<Fn> + <Pg Dn>		Předchozí	Návrat na předchozí mediální soubor.
<Fn> + <End>		Další	Přeskočit na další mediální soubor.



## Pohled na zavřenou přední stranu



#	Ikona	Položka	Popis
1		Čtečka karet Více v 1	<p>Podporuje karty Secure Digital (SD), MultiMediaCard (MMC), Memory Stick (MS), Memory Stick PRO (MS PRO) a xD-Picture Card (xD).</p> <p><b>Poznámka:</b> Stisknutím vyjměte nebo vložte kartu. V jednom okamžiku lze použít jen jednu kartu.</p>







## Pohled zprava

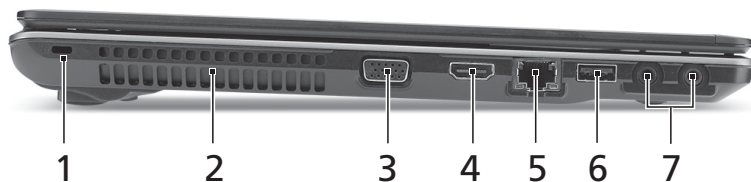

#	Ikona	Položka	Popis
1		Port USB 2.0	Umožňují připojení zařízení s rozhraním USB 2.0 (například myš nebo fotoaparát USB).
2		Optická jednotka	Interní optická jednotka, používá disky CD a DVD.
3		Indikátor přístupu k optickému disku	Svítlí, pokud je optická jednotka aktivní.
4		Otvor pro nouzové vysunutí	Umožňuje vysunutí přihrádky optické jednotky, pokud je počítač vypnutý. <b>Poznámka:</b> Chcete-li vysunout přihrádku optické jednotky, jestliže je počítač vypnutý, vložte do otvoru pro nouzové vysunutí kancelářskou sponku.
5		Napájecí konektor	Zajišťuje připojení k síťovému adaptéru.





## Pohled zleva

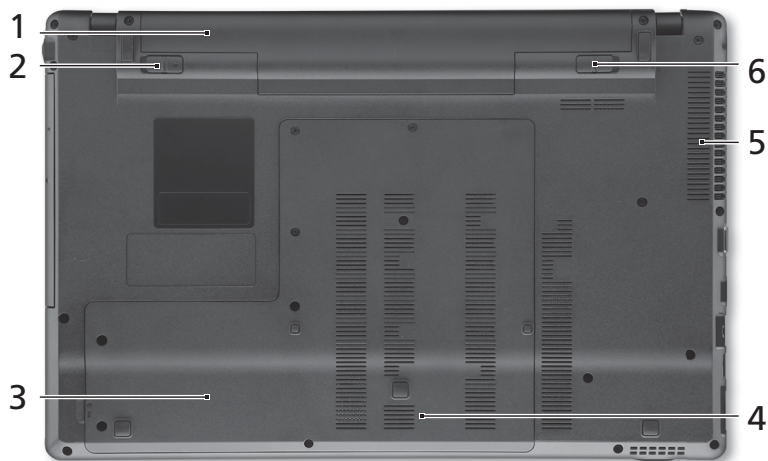

#	Ikona	Položka	Popis
1		Patice pro zámek Kensington	Umožňuje připojení počítačového bezpečnostního zámku kompatibilního s typem Kensington.
2		Ventilační otvory	Umožňují chlazení počítače i při dlouhodobém používání.
3		Port externího zobrazovacího zařízení (VGA)	Umožňuje připojení zobrazovacího zařízení (například externího monitoru nebo projektoru LCD).
4		Port HDMI	Podporuje připojení digitálního videa ve vysokém rozlišení.
5		Port Ethernet (RJ-45)	Slouží k připojení počítače k síti Ethernet 10/100/1000.
6		Port USB 2.0	Umožňují připojení zařízení s rozhraním USB 2.0 (například myš nebo fotoaparát USB).
7		Konektor mikrofonu	Slouží k připojení vstupů z externího mikrofonu.
		Konektor pro připojení sluchátek, reproduktorů nebo zvukového výstupu s podporou rozhraní S/PDIF	Slouží k připojení výstupních zvukových zařízení (například reproduktorů nebo sluchátek).

## Pohled zespodu



#	Ikona	Položka	Popis
1		Pozice pro baterii	Zde je uložena baterie počítače.
2		Zámek baterie	Zamkne baterii na místě.
3		Pozice pro pevný disk	Zde je uložen pevný disk počítače (zajištěný šroubem).
4		Pozice pro paměť	Zde je uložena hlavní paměť počítače.
5		Ventilační otvory a ventilátor	Umožňují chlazení počítače i při dlouhodobém používání. <b>Poznámka:</b> Nezakrývejte ani neblokuje otvor ventilátoru.
6		Uvolňovací západka baterie	Uvolňuje baterii k vyjmutí.

## Prostředí

---

- Teplota:
    - Provozní: 5°C až 35°C
    - Neprovozní: -20°C až 65°C
  - Vlhkost (nekondenzující):
    - Provozní: 20% až 80%
    - Neprovozní: 20% až 80%
- 



.....

**Poznámka:** Výše uvedená specifikace je pouze referenční.  
Přesná konfigurace počítače závisí na zakoupeném modelu.

# Séria Aspire 5745/5553

Stručná príručka

© 2010 Všetky práva vyhradené.

Stručná príručka pre sériu Aspire 5745/5553

Pôvodné vydanie: 03/2010

Prenosný počítač série Aspire 5745/5553

Číslo modelu: \_\_\_\_\_

Sériové číslo: \_\_\_\_\_

Dátum zakúpenia: \_\_\_\_\_

Miesto zakúpenia: \_\_\_\_\_

# Hneď na úvod

Radi by sme vám poďakovali za rozvoj prenosných počítačov série Acer - vašej voľby pre vaše mobilné počítačové potreby.

## Vaše príručky

Aby sme vám pomohli s používaním Acer, vytvorili sme pre vás sadu príručiek:

V prvom rade plagát **Práve začíname...**, ktorý vám pomôže začať s nastavením vášho počítača.

**Všeobecná používateľská príručka pre sériu Aspire** obsahuje užitočné informácie týkajúce sa všetkých modelov v produktovom rade Aspire. Obsahuje základné témy, ako napríklad informácie o používaní klávesnice, zvuku atď. Majte teda na pamäti, že **Všeobecná používateľská príručka** ako aj **AcerSystem User Guide**, ktorá je spomenutá ďalej, občas obsahujú informácie o funkciách a vlastnostiach, ktorými sú vybavené iba určité modely produktovej série a model, ktorý si zakúpili, nimi nemusí byť vybavený. Opis takýchto funkcií je v texte označený poznámkou v zmysle „len pre určité modely“.

**Stručná príručka** sú základné funkcie a vlastnosti vášho nového počítača. Informácie o tom, ako vám počítač pomôže byť produktívnejší, nájdete v **AcerSystem User Guide**. Táto príručka obsahuje podrobné informácie o systémových programoch, obnove dát, možnostiach rozšírenia a riešenie problémov. Okrem toho obsahuje informácie o záruke a všeobecné vyhlásenia k predpisom a bezpečnosti. Je dostupná vo formáte PDF a je umiestnená vo vašom prenosnom počítači. Ak si chcete pozrieť jej obsah, postupujte podľa nasledovných krokov:

- 1 Kliknite na  **Štart > Všetky programy > AcerSystem**.
- 2 Kliknite na **AcerSystem User Guide**.



.....

**Poznámka:** Prezeranie súboru vyžaduje Adobe Reader. Ak na vašom počítači nie je Adobe Reader nainštalovaný, kliknutím na **AcerSystem User Guide** sa najprv spustí inštalácia programu Adobe Reader. Inštaláciu dokončíte podľa inštrukcií, ktoré uvidíte na obrazovke. Inštrukcie ako používať Adobe Reader nájdete v menu **Pomocník a Podpora**.

# Zoznámte sa so svojím prenosným počítačom Acer





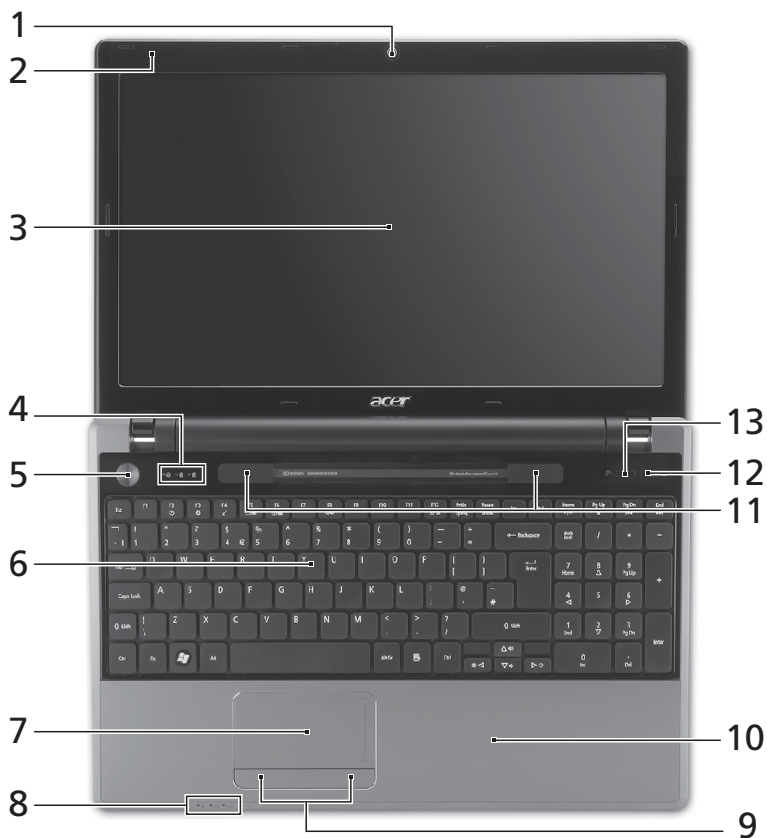

Po nastavení počítača podľa letáku nám dovoľte, aby sme vás zoznámili s vaším novým prenosným počítačom Acer.

## Pohľad zhora



#	Ikona	Položka	Popis
1		Webkamera Acer Crystal Eye	Webová kamera na video komunikáciu (len pre určité modely).

















#	Ikona	Položka	Popis
2		Mikrofón	Interný mikrofón na nahrávanie zvuku.
3		Obrazovka	Nazýva sa tiež Liquid-Crystal Display (LCD), zobrazuje výstup z počítača (konfigurácia sa môže v závislosti od modelu líšiť).
4		Kontrolka pevného disku	Svieti, keď je jednotka pevného disku aktívna.
		Kontrolka Num Lock	Svieti, keď je Num Lock aktivovaný.
		Kontrolka Caps Lock	Svieti, keď je Caps Lock aktivovaný.
5		Tlačidlo Zapnúť	Zapína a vypína počítač.
6		Klávesnica	Služi na zadávanie údajov do počítača.
7		Dotyková plocha	Zariadenie s citlivosťou na dotyk, ktoré funguje ako počítačová myš.
8		Kontrolka napájania <sup>1</sup>	Signalizuje stav napájania počítača.
		Kontrolka batérie <sup>1</sup>	Signalizuje stav batérie počítača. <b>1. Nabíjanie:</b> Pri nabíjaní batérie svieti žltá. <b>2. Nabité:</b> V režime AC svieti modrá.
		Kontrolka komunikácie <sup>1</sup>	Signalizuje stav zariadenia na bezdrôtovú komunikáciu v počítači.
9		Tlačidlá na klikanie (ľavé a pravé)	Funkcia ľavého a pravého tlačidla je podobná ako funkcia ľavého a pravého tlačidla myši.
10		Podložka rúk	Pohodlná opora rúk pri práci s počítačom.
11		Reprodukory	Ľavý a pravý reproduktor poskytujúci stereo audio výstup.
12		Tlačidlo vysúvania optickej mechaniky	Vysúva optický disk z jednotky.
13		Programovateľný kláves	Programovateľný užívateľom (len pre určité modely).
		Kláves PowerSmart	Uvedie počítač do režimu úspory energie (len pre určité modely).

1. Kontrolky na prednom paneli sú viditeľné, aj keď je veko počítača zatvorené.

## Klávesové skratky

Počítač využíva klávesové skratky alebo kombinácie klávesov na prístup k väčšine nastavení počítača, ako je napríklad jas obrazovky a hlasitosť výstupu.

Ak chcete aktivovať klávesové skratky, stlačte a podržte kláves **<Fn>** pred stlačením ďalšieho klávesu v klávesovej skratke.

Klávesová skratka	Ikona	Funkcia	Popis
<Fn> + <F3>		Kláves komunikácie	Zapína a vypína komunikačné zariadenia počítača (Komunikačné zariadenia sa môžu líšiť v závislosti od konfigurácie).
<Fn> + <F4>		Režim spánku	Prepne počítač do režimu spánku.
<Fn> + <F5>		Prepínanie zobrazenia	Prepína výstup zobrazenia – obrazovka, externý monitor (ak je pripojený) a obidva súčasne.
<Fn> + <F6>		Vypnutie obrazovky	Vypína podsvietenie obrazovky kvôli úspore energie. Pre návrat stlačte akúkoľvek klávesu.
<Fn> + <F7>		Prepínanie dotykovej plochy	Zapína a vypína internú dotykovú plochu.
<Fn> + <F8>		Prepínanie reproduktora	Zapína a vypína reproduktory.
<Fn> + <▷>		Zvýšenie jasu	Zvyšuje jas obrazovky.
<Fn> + <◁>		Zníženie jasu	Znižuje jas obrazovky.
<Fn> + <△>		Zvýšenie hlasitosti	Zvyšuje hlasitosť zvuku.
<Fn> + <▽>		Zníženie hlasitosti	Znižuje hlasitosť zvuku.
<Fn> + <Home>		Prehrať/ Pozastaviť	Prehrávanie alebo pozastavenie vybraného súboru média.
<Fn> + <Pg Up>		Zastaviť	Zastavenie prehrávania vybraného súboru média.
<Fn> + <Pg Dn>		Predch.	Návrat na predchádzajúci súbor média.
<Fn> + <End>		Ďalej	Preskočenie na nasledujúci súbor média.

## Pohľad spredu (zatvorený)



#	Ikona	Položka	Popis
1		Čítačka kariet Multi-in-1	Podporuje karty Secure Digital (SD), MultiMediaCard (MMC), Memory Stick (MS), Memory Stick PRO (MS PRO) a xD-Picture Card (xD). <b>Poznámka:</b> Stlačením vyťahnete/vložíte kartu. Nie je možné pracovať s viacerými kartami naraz.







## Pohľad sprava

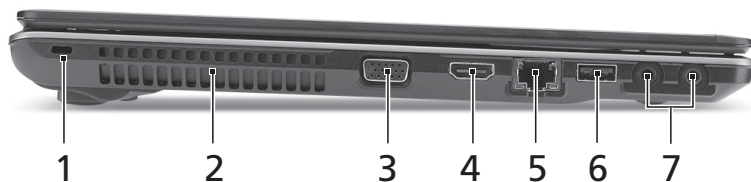

#	Ikona	Položka	Popis
1		Port USB 2.0	Prípojenie zariadení cez rozhranie USB 2.0 (napr. USB myš, USB fotoaparát).
2		Optická mechanika	Interná optická mechanika na CD alebo DVD disky.
3		Indikátor prístupu na optický disk	Svieti, keď je optická mechanika aktívna.
4		Otvor núdzového vysúvania	Vysúva optickú mechaniku pri vypnutom počítači. <b>Poznámka:</b> Keď je počítač vypnutý, optickú jednotku vysuniete zasunutím kancelárskej sponky do núdzového otvoru.
5		Konektor vstupu jednosmerného napätia	Prípojenie adaptéra striedavého napätia.





## Pohľad zľava

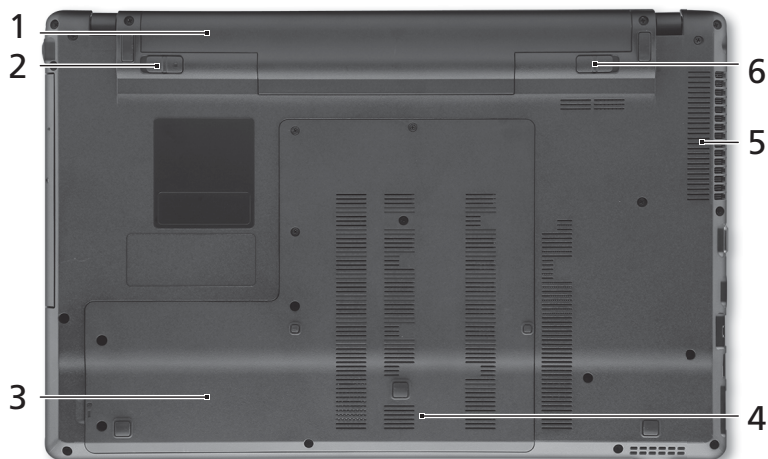

#	Ikona	Položka	Popis
1		Zásuvka na zámok Kensington	Pripojenie počítačového bezpečnostného kľúča Kensington.
2		Otvory na ventiláciu	Pomáha udržať pri dlhom používaní počítač chladný.
3		Port externej obrazovky (VGA)	Pripojenie zobrazovacieho zariadenia (napr. externého monitora, LCD projektor).
4		Port HDMI	Podporuje pripojenie digitálneho videa s vysokým rozlíšením.
5		Port siete Ethernet (RJ-45)	Pripojenie k sieti Ethernet 10/100/1000.
6		Port USB 2.0	Pripojenie zariadení cez rozhranie USB 2.0 (napr. USB myš, USB fotoaparát).
7		Konektor mikrofónu	Slúži na vstup zvuku z externých mikrofónov.
		Výstup s podporou S/PDIF na slúchadlá/reproduktor/externé zvukové zariadenie	Výstup zvuku do zvukových zariadení (napr. reproduktorov, slúchadiel).

## Pohľad zdola



#	Ikona	Položka	Popis
1		Jednotka batérie	Slúži na uloženie batérie počítača.
2		Zámok batérie	Uzamyká batériu na jej mieste.
3		Jednotka pevného disku	Slúži na uchytenie pevného disku počítača (zaistené skrutkami).
4		Pozícia pre pamäť	Tu je uložená hlavná pamäť počítača.
5		Otvory na ventiláciu a ventilátor chladenia	Pomáha udržať pri dlhom používaní počítač chladný. <b>Poznámka:</b> Neuzatvárajte ani neupchávajújte otvor vetráka.
6		Západka uvoľnenia batérie	Slúži na uvoľnenie batérie pri jej vyberaní.

## Prostredie

---

- Teplota:
    - Prevádzková: 5°C až 35°C
    - Mimoprevádzková: -20°C až 65°C
  - Vlhkosť (nekondenzačná):
    - Prevádzková: 20% až 80%
    - Mimoprevádzková: 20% až 80%
- 



.....

**Poznámka:** Vyššie uvedené vlastnosti sú len informačné.  
Presná konfigurácia počítača závisí od zakúpeného modelu.

# Seriya Aspire 5745/5553

Hitri vodič

© 2010 Vse pravice pridržane.

Hitri vodič za serijo Aspire 5745/5553

Originalna izdaja: 03/2010

Prenosni računalnik serije Aspire 5745/5553

Številka modela: \_\_\_\_\_

Serijska številka: \_\_\_\_\_

Datum nakupa: \_\_\_\_\_

Mesto nakupa: \_\_\_\_\_



# Najprej začetek

Želimo se vam zahvaliti, ker ste za zadovoljevanje prenosnih računalniških potreb izbrali prenosnik Acer.

## Vaša navodila

Za pomoč pri uporabi vašega prenosnika Acer, smo izdelali paket navodil:

Za začetek vam plakat **Za začetek...** pomaga pri nastavljanju vašega računalnika.

**Splošni uporabniški priročnik serije Aspire** vsebuje uporabne informacije, ki veljajo za vse modele serije izdelkov Aspire. Pokriva osnovne teme, kot so uporaba tipkovnice in nastavitve zvoka itd. Prosimo, da upoštevate, da bosta se **Splošni uporabniški priročnik** kot tudi **uporabniški priročnik AcerSystem (AcerSystem User Guide)** omenjen spodaj, zaradi svoje splošne narave včasih nanašala na funkcije ali lastnosti, ki jih imajo le nekateri modeli iz serije, ne pa nujno tudi model, ki ste ga kupili. Takšni primeri so označeni z napisom „velja le za določene modele“.

**Hitri vodič** vsebuje osnovne funkcije vašega novega računalnika. Za več informacije o tem kako vam lahko računalnik pomaga do večje produktivnosti, prosimo glejte **uporabniški priročnik AcerSystem (AcerSystem User Guide)**. Ta navodila vsebujejo podrobne informacije o sistemskih pripomočkih, obnovi podatkov, možnostih razširitve in odpravljanju težav. Poleg tega vsebuje garancijske informacije in splošne uredbe in varnostna obvestila za vaš prenosnik. Navodila so na voljo v obliki prenosnega dokumenta (PDF) in so naložena na vaš prenosnik. Za navodila sledite tem korakom:

- 1 Kliknite  **Start > Vsi programi > AcerSystem**.
- 2 Kliknite na **uporabniški priročnik AcerSystem (AcerSystem User Guide)**.



-----

**Opomba:** Za pregledovanje datoteke potrebujete Adobe Reader. Če Adobe Reader ni nameščen na računalnik se bo zagnal namestitveni program Adobe Reader, ko kliknete na **uporabniški priročnik AcerSystem (AcerSystem User Guide)**. Za zaključek postopka sledite navodilom na zaslonu. Za navodila o uporabi Adobe Reader, odprite meni **Help and Support**.







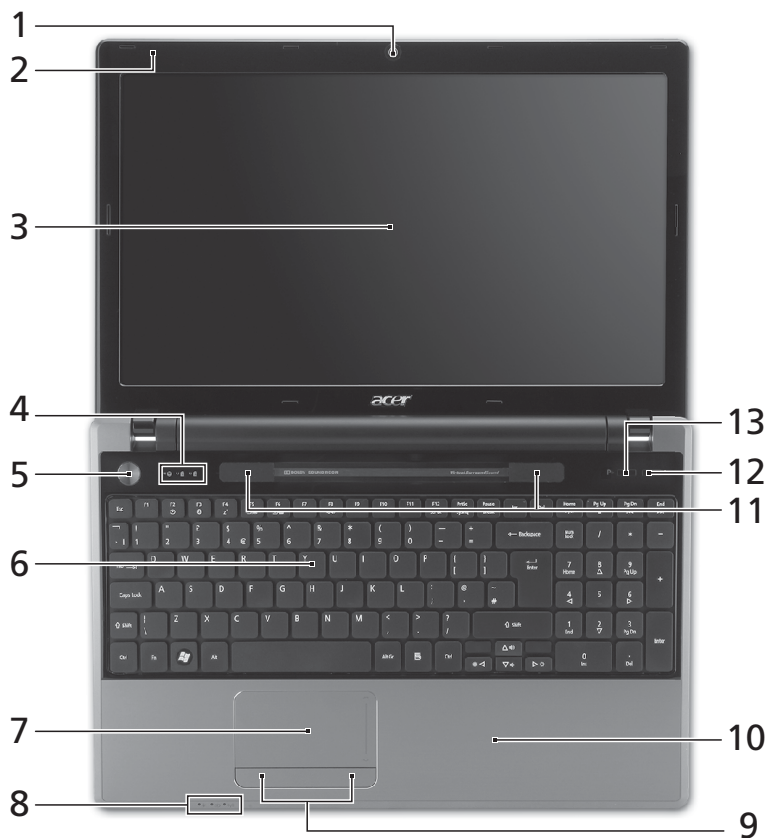

# Vodič po vašem prenosniku Acer

Ko ste nastavili računalnik, kot je prikazano na plakatu, dovolite, da vam predstavimo vaš novi prenosnik Acer.

## Pogled od zgoraj



#	Ikona	Predmet	Opis
1		Integrirana spletna kamera Acer Crystal Eye	Spletna kamera za video komunikacijo (le na določenih modelih).
2		Mikrofon	Notranji mikrofon za snemanje zvoka.

#	Ikona	Predmet	Opis
3		Zaslon	Takoimenovani zaslon s tekoimi kristali (LCD), prikazuje izhod vašega računalnika (konfiguracija je za različne modele razlina).
4		Indikator trdega diska	Označuje, ko je trdi disk aktiven.
		Indikator možnosti Num Lock	Zasveti, ko je tipka Num Lock aktivirana.
		Indikator možnosti Caps Lock	Zasveti, ko je tipka Caps Lock aktivirana.
5		Tipka za vklop/izklop	Vklop in izklop računalnika.
6		Tipkovnica	Za vnos podatkov v računalnik.
7		Sledilna plošča	Na dotik občutljiva naprava, ki deluje kot računalniška miška.
8		Indikator stanja napajanja <sup>1</sup>	Označuje stanje napajanja računalnika.
		Indikator stanja baterije <sup>1</sup>	Označuje stanje baterije računalnika. <b>1. Polnjenje:</b> Lučka sveti rumenkasto rjavo, ko se baterija polni. <b>2. V celoti napolnjena:</b> V načinu AC lučka sveti modro.
		Indikator komunikacije <sup>1</sup>	Označuje stanje naprave za brezžično povezavo.
9		Tipke (levo in desno)	Leva in desna tipka delujejo kot leva in desna tipka na miški.
10		Podpora za dlan	Udobna podpora za vaše roke, ko uporabljate računalnik.
11		Zvočniki	Levi in desni zvočnik nudita stereo zvočni izhod.
12		Tipka za izvreči optični pogon	Izvrže optični disk iz pogona.
13	<b>P</b>	Programirljiva tipka	Programirljivo (le na določenih modelih).
		Tipka PowerSmart	Preklopi računalnik v stanje varčevanja z energijo (le na določenih modelih).

1. Indikatorji na sprednji plošči so vidni tudi, ko je pokrov računalnika zaprt.

## Vročne tipke

Računalnik uporablja vroče tipke ali kombinacijo tipk za dostop do računalniških nastavitev kot sta svetlost zaslona in glasnost.

Za aktiviranje vročih tipk pritisnite in držite tipko **<Fn>** preden pritisnete drugo tipko v kombinaciji.

Vročna tipka	Ikona	Funkcija	Opis
<b>&lt;Fn&gt; + &lt;F3&gt;</b>		Komunikacijska tipka	Omogoči/onemogoči komunikacijske naprave računalnika (Komunikacijske naprave se lahko razlikujejo po konfiguraciji).
<b>&lt;Fn&gt; + &lt;F4&gt;</b>		Mirovanje	Preklopi računalnik v stanje mirovanja.
<b>&lt;Fn&gt; + &lt;F5&gt;</b>		Preklop zaslona	Preklopi izhod zaslona med zaslonom, zunanjim monitorjem (če je priključen) in obema.
<b>&lt;Fn&gt; + &lt;F6&gt;</b>		Izklop zaslona	Izključi luč zaslona za varčevanje z energijo. Pritisnite poljubno tipko za vrnitev.
<b>&lt;Fn&gt; + &lt;F7&gt;</b>		Preklop sledilne plošče	Vključi in izključi notranjo sledilno ploščo.
<b>&lt;Fn&gt; + &lt;F8&gt;</b>		Preklop zvočnikov	Vklop in izklop zvočnikov.
<b>&lt;Fn&gt; + &lt;▷&gt;</b>		Poveča svetlost	Poveča svetlost zaslona.
<b>&lt;Fn&gt; + &lt;◁&gt;</b>		Zmanjša svetlost	Zmanjša svetlost zaslona.
<b>&lt;Fn&gt; + &lt;△&gt;</b>		Povečanje glasnosti	Poveča glasnost zvoka.
<b>&lt;Fn&gt; + &lt;▽&gt;</b>		Zmanjšanje glasnosti	Zmanjša glasnost zvoka.
<b>&lt;Fn&gt; + &lt;Home&gt;</b>		Predvajaj/ Premor	Predvaja ali zaustavi izbrano medijsko datoteko.
<b>&lt;Fn&gt; + &lt;Pg Up&gt;</b>		Zaustavitev	Zaustavi predvajanje izbrane medijske datoteke.
<b>&lt;Fn&gt; + &lt;Pg Dn&gt;</b>		Predhodni	Vrnitev na predhodno medijsko datoteko.
<b>&lt;Fn&gt; + &lt;End&gt;</b>		Naslednji	Skok na naslednjo medijsko datoteko.

## Zaprto pogled od spredaj



#	Ikona	Predmet	Opis
1		Čitalec kartic več-v-1	<p>Sprejema Secure Digital (SD), MultiMediaCard (MMC), Memory Stick (MS), Memory Stick Pro (MS PRO), in xD-kartico za fotografije.</p> <p><b>Opomba:</b> Pritisnite, da bi odstranili/vstavili kartico. Naenkrat lahko uporabljate le eno kartico.</p>







## Pogled iz desne strani

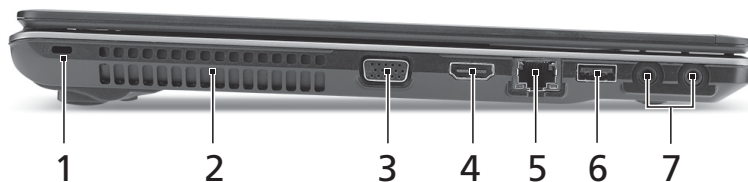

#	Ikona	Predmet	Opis
1		Vrata USB 2.0	Priključek za naprave USB 2.0 (npr., USB miška, USB fotoaparat).
2		Optični pogon	Notranji optični pogon; sprejema CD-je ali DVD-je.
3		Pokazatelj dostopa do optičnega diska	Zasveti, ko je optični pogon aktiven.
4		Luknja za izvržbo v nujnem primeru	<p>Izvrže pladenj optičnega pogona, ko je računalnik izključen.</p> <p><b>Opomba:</b> Vstavite sponko v luknjo za izvržbo v nujnem primeru, da izvržete pladenj optičnega pogona, ko je računalnik izključen.</p>
5		Priključek napajalnika	Priključek na AC napajalnik.





## Pogled iz leve strani

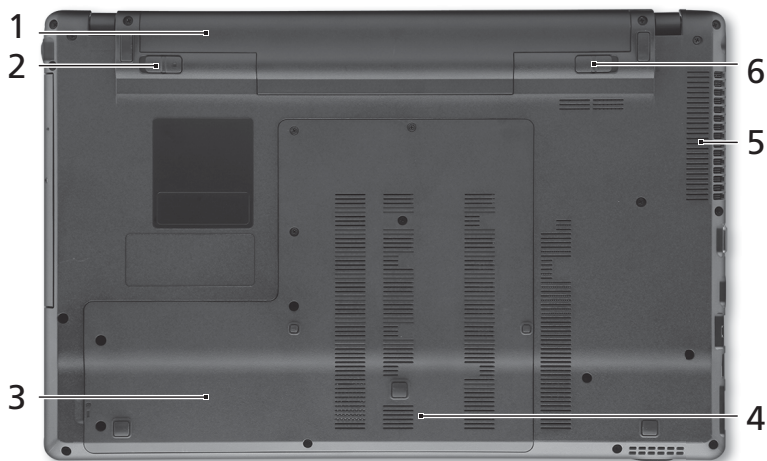

#	Ikona	Predmet	Opis
1		Reža za zaklep Kensington	Priključek za Kensington združljivo računalniško ključavnico.
2		Reže za prezračevanje	Omogočajo, da računalnik ostane hladen tudi po dolgotrajni uporabi.
3		Priključek za zunanji zaslon (VGA)	Priključitev na prikazovalno napravo (npr. zunanji monitor, projektor LCD).
4		Vhod HDMI	Podpira priključke za visokoločljivostni digitalni video.
5		Priključek Ethernet (RJ-45)	Priključek na omrežja Ethernet 10/100/1000.
6		Vrata USB 2.0	Priključek za naprave USB 2.0 (npr., USB miška, USB fotoaparati).
7		Vtičnica za mikrofona	Sprejema vhode iz zunanjih mikrofonov.
		Vhod za slušalke/zvočnike/naprave s podporo S/PDIF	Priključek za avdio naprave (npr. zvočniki, slušalke).

## Pogled od spodaj



#	Ikona	Predmet	Opis
1		Nosilec za baterijo	Hrani baterijo računalnika.
2		Zaklep za baterijo	Zaklene baterijo na mesto.
3		Nosilec trdega diska	Hrani trdi disk računalnika (pričvrščeno z vijaki).
4		Razdelek za pomnilnik	Hrani glavni spomin računalnika.
5		Reže za prezračevanje in hladilni ventilator	Omogočajo, da računalnik ostane hladen tudi po dolgotrajni uporabi. <b>Opomba:</b> Odprtine ventilatorja ne prekrivajte ali zapirajte.
6		Zapah za sprostitve baterije	Sprostitev baterije za odstranjevanje.

## Okolje

---

- Temperatura:
    - Delovanje: 5°C do 35°C
    - Mirovanje: -20°C do 65°C
  - Vlažnost (brez kondenza):
    - Delovanje: 20% do 80%
    - Mirovanje: 20% do 80%
- 



.....

**Opomba:** Zgoraj omenjeni tehnični podatki so le za referenco.  
Dejanska konfiguracija vašega računalnika je odvisna od kupljenega modela.



# Aspire 5745/5553 serije

Kratki vodič

© 2010 Sva prava pridržana.

Aspire 5745/5553 serije - kratki vodič  
Izvorno izdanje: 03/2010

Aspire 5745/5553 serije prijenosno osobno računalo

Broj modela: \_\_\_\_\_

Serijski broj: \_\_\_\_\_

Datum kupovine: \_\_\_\_\_

Mjesto kupovine: \_\_\_\_\_

# Prvo osnovne stvari

Željeli bismo zahvaliti na izboru Acer prijenosnog računala koje će vam poslužiti kamo god krenuli.

## Vaši vodiči

Kako bismo pomogli pri uporabi vašeg Acer prijenosnog računala, za vas smo pripremili sljedeće vodiče:

Na prvom mjestu, poster **Tek za početak...** pomaže pri početnim postupcima i postavljanju vašeg računala.

**Opći priručnik za korisnike Aspire serije** sadrži korisne informacije koje se odnose na sve modele Aspire serije proizvoda. Priručnik obuhvaća osnovne teme poput uporabe tipkovnice, audia, i sl. Obratite pažnju na činjenicu kako zbog načina izdanja **Opći priručnik za korisnike** kao i **AcerSystem korisnički vodič (AcerSystem User Guide)** koji su navedeni dolje, ponekad navodite obilježja ili funkcije koje su dostupne samo s određenim modelima serije, ali ne nužno i na vašem modelu. U takvim slučajevima bit će naveden tekst poput "samo za određene modele".

**Kratki vodič** upoznaje vas s osnovnim obilježjima i funkcijama vašeg novog računala. Za više informacija o tome kako vam vaše računalo može pomoći da budete produktivniji, molimo, pogledajte **AcerSystem korisnički vodič (AcerSystem User Guide)**. Priručnik sadrži detaljne informacije o temama kao što su uslužni programi sustava, vraćanje podataka, opcije za proširivanje i rješavanje problema. Nadalje, sadrži informacije o jamstvima i osnovne obavijesti o propisima i sigurnosti za vaš prijenosnik. On je dostupan u Portable Document Formatu (PDF) i dolazi prethodno učitani u vaš prijenosnik. Slijedite ove korake da biste mu pristupili:

- 1 Kliknite na  **Start > Svi programi > AcerSystem.**
- 2 Kliknite na **AcerSystem korisnički vodič (AcerSystem User Guide).**



.....

**Napomena:** Pregled dokumenta zahtijeva Adobe Reader. Ako Adobe Reader nije instaliran na vaše računalo, klik na **AcerSystem korisnički vodič (AcerSystem User Guide)** prvo će pokrenuti program za instalaciju Adobe Readera. Slijedite upute na zaslonu da biste završili instalaciju. Za upute kako koristiti Adobe Reader, pristupite izborniku **Pomoć i podrška.**

# Upoznajte Vaš Acer prijenosnik

Nakon postavljanja vašeg računala kao što je ilustrirano posterom, dopustite nam da Vas upoznamo s Vašim novim Acer prijenosnikom.

## Pogled odozgo

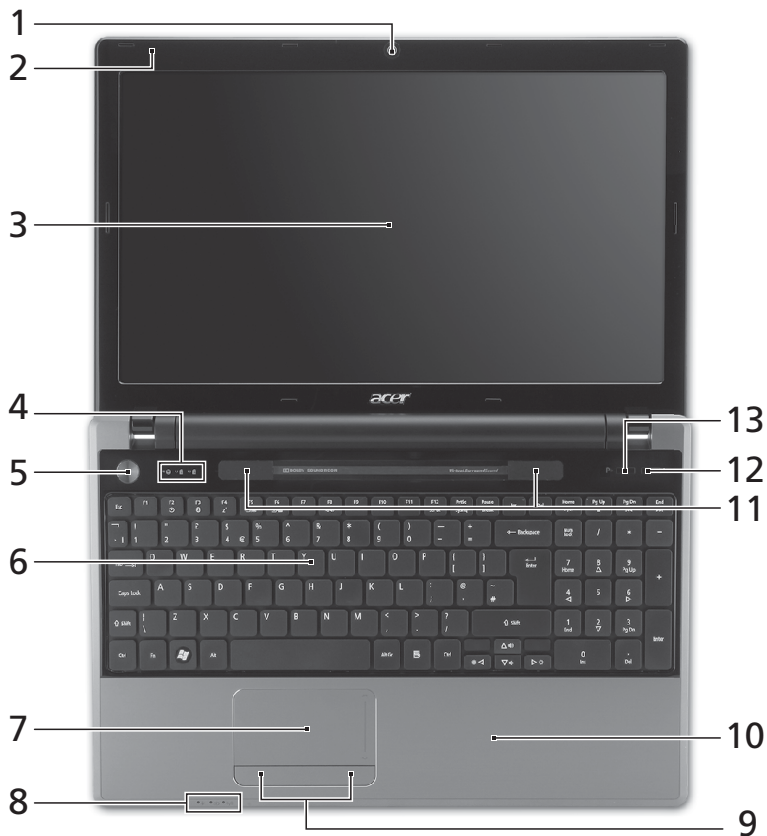

#	Ikona	Stavka	Opis
1		Acer Crystal Eye web kamera	Web kamera za video komunikaciju (samo za određene modele).
2		Mikrofon	Unutarnji mikrofon za snimanje zvuka.















#	Ikona	Stavka	Opis
3		Zaslon prikaza	Također nazivan i Liquid-Crystal Display (LCD), prikazuje izlaz računala (Konfiguracija se može razlikovati ovisno o modelu).
4		HDD indikator	Pokazuje kada je pogon tvrdog diska aktivan.
		Num Lock indikator	Svijetli kada je Num Lock aktiviran.
		Caps Lock indikator	Svijetli kada je Caps Lock aktiviran.
5		Gumb za uključivanje	Uključuje i isključuje računalo.
6		Tipkovnica	Za unos podataka u vaše računalo.
7		Dodirna ploča	Pokazivački uređaj osjetljiv na dodir koji funkcionira kao računalni miš.
8		Indikator napajanja <sup>1</sup>	Pokazuje stanje napajanja računala.
		Indikator baterije <sup>1</sup>	Pokazuje stanje baterije računala. <b>1. Punjenje:</b> Svijetli žuto kada se baterija puni. <b>2. Sasvim napunjeno:</b> Svijetli plavo kada radi na izmjeničnom napajanju.
		Indikator komunikacije <sup>1</sup>	Pokazuje status uređaja za bežično spajanje računala.
9		Tipke za klikanje (lijeva i desna)	Lijeva i desna tipka funkcionira kao lijeva i desna tipka miša.
10		Oslonac za dlanove	Udobno područje koje pruža potporu Vašim rukama kada koristite računalo.
11		Zvučnici	Lijevi i desni zvučnik pružaju stereo audio izlaz.
12		Gumb za izbacivanje optičkog pogona	Izbacuje optički disk iz pogona.
13	<b>P</b>	Programabilna tipka	Korisnički programabilna (samo za određene modele).
		PowerSmart tipka	Računalo pokreće rad s uštedom energije (samo za određene modele).

1. Indikatori na prednjoj ploči su vidljivi čak i kada je poklopac računala zatvoren.

## „Vruće“ tipke

Računalo koristi „vruće“ tipke ili kombinacije tipki za pristup većini upravljačkih tipki računala, kao što je osvjetljenost zaslona i izlazna glasnoća.

Za aktiviranje „vruće“ tipke, pritisnite i držite **<Fn>** tipku prije pritiskanja druge tipke u kombinaciji „vrućih“ tipki.

„Vruće“ tipke	Ikona	Funkcija	Opis
<b>&lt;Fn&gt; + &lt;F3&gt;</b>		Tipka za komunikaciju	Omogućava/onemogućava komunikacijske uređaje računala (Komunikacijski uređaji variraju prema konfiguraciji).
<b>&lt;Fn&gt; + &lt;F4&gt;</b>		Stanje mirovanja	Stavlja računalo u stanja mirovanja.
<b>&lt;Fn&gt; + &lt;F5&gt;</b>		Prekidač prikaza	Prebacuje izlaz prikaza između zaslona prikaza, vanjskog monitora (ako je priključen) i oba.
<b>&lt;Fn&gt; + &lt;F6&gt;</b>		Isključivanje zaslona	Isključuje pozadinsko osvjetljenje zaslona prikaza radi uštede energije. Pritisnite bilo koju tipku da se vratite.
<b>&lt;Fn&gt; + &lt;F7&gt;</b>		Prekidač dodirne ploče	Uključuje i isključuje unutarnju dodirnu ploču.
<b>&lt;Fn&gt; + &lt;F8&gt;</b>		Prekidač zvučnika	Uključuje i isključuje zvučnike.
<b>&lt;Fn&gt; + &lt;▷&gt;</b>		Povećanje osvjetljenosti	Povećava osvjetljenost zaslona.
<b>&lt;Fn&gt; + &lt;◁&gt;</b>		Smanjivanje osvjetljenosti	Smanjuje osvjetljenost zaslona.
<b>&lt;Fn&gt; + &lt;△&gt;</b>		Pojačavanje glasnoće	Pojačava glasnoću zvuka.
<b>&lt;Fn&gt; + &lt;▽&gt;</b>		Smanjivanje glasnoće	Smanjuje glasnoću zvuka.
<b>&lt;Fn&gt; + &lt;Home&gt;</b>		Izvođenje/stanka	Reproducira ili zaustavlja reprodukciju odabrane medijske datoteke.
<b>&lt;Fn&gt; + &lt;Pg Up&gt;</b>		Zaustavljanje	Zaustavlja reprodukciju odabrane medijske datoteke.
<b>&lt;Fn&gt; + &lt;Pg Dn&gt;</b>		Prethodno	Povrat na prethodnu medijsku datoteku.
<b>&lt;Fn&gt; + &lt;End&gt;</b>		Sljedeće	Skok na sljedeću medijsku datoteku.

## Pogled sprijeda izbliza



#	Ikona	Stavka	Opis
1		Više-u-1 čitač kartica	<p>Prihvaća Secure Digital (SD), MultiMediaCard (MMC), Memory Stick (MS), Memory Stick PRO (MS PRO), xD-Picture Card (xD) kartice.</p> <p><b>Napomena:</b> Gurnite za uklanjanje/postavljanje kartice. U bilo koje vrijeme samo jedna kartica može biti stavljena u pogon.</p>







## Pogled s desne strane

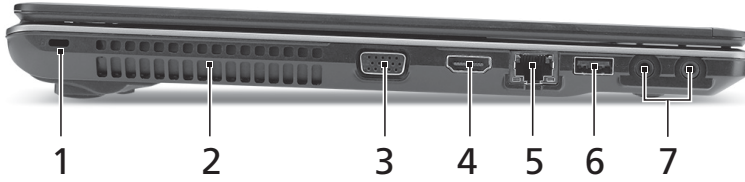

#	Ikona	Stavka	Opis
1		USB 2.0 priključak	Povezuje se sa USB 2.0 uređajima (primjerice USB miš, USB kamera).
2		Optički pogon	Unutarnji optički pogon; prihvaća CD-e ili DVD-e.
3		Indikator pristupa optičkom disku	Svijetli kada je optički pogon aktivan.
4		Otvor za izbacivanje u slučaju nužde	<p>Izbacuje ladicu optičkog pogona kada je računalo isključeno.</p> <p><b>Napomena:</b> Umetnite spajalicu za papir u otvor za izbacivanje u slučaju nužde da izbacite ladicu optičkog pogona kada je računalo isključeno.</p>
5		DC-in utičnica	Povezuje se s AC adapterom.

## Pogled s lijeve strane







#	Ikona	Stavka	Opis
1		Utor za Kensington bravu	Povezuje se s Kensington - kompatibilnom računalom sigurnosnom bravom.
2		Utori za prozračivanje	Omogućavaju rashlađivanje računala i prilikom dugotrajne uporabe.
3		Priključak vanjskog ekrana (VGA)	Povezuje se s uređajem za prikaz (primjerice vanjskim monitorom, LCD projektorom).
4		HDMI ulaz	Podržava veze digitalnog videa visoke definicije.
5		Ethernet (RJ-45) priključak	Povezuje se na Ethernet 10/100/1000-baziranu mrežu.
6		USB 2.0 priključak	Povezuje se sa USB 2.0 uređajima (primjerice USB miš, USB kamera).
7		Utičnica za mikروفon	Prihvata ulaze iz vanjskih mikrofona.
		Utičnica za slušalice/zvučnike/line-out sa S/PDIF podrškom	Povezuje se sa line-out audio uređajima (npr. zvučnicima, slušalicama).

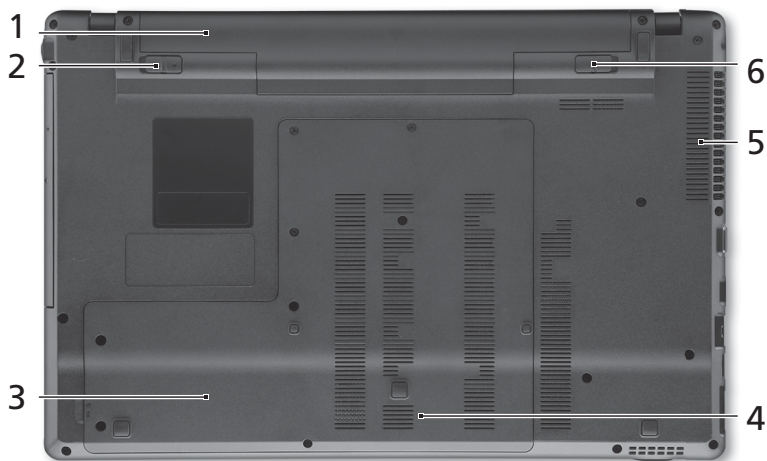

## Pogled odozdo



#	Ikona	Stavka	Opis
1		Prostor za bateriju	Sadrži baterijski komplet računala.
2		Brava baterije	Zaključava bateriju u njen položaj.
3		Prostor za tvrdi disk	Sadrži tvrdi disk računala (učvršćen vijcima).
4		Odjeljak za memoriju	Sadrži glavnu memoriju računala.
5		Utori za provjetravanje i ventilator za hlađenje	Omogućavaju rashlađivanje računala i prilikom dugotrajne uporabe. <b>Napomena:</b> Nemojte prekriti ili prepriječiti otvor ventilatora.
6		Bravica za oslobađanje baterije	Oslobađa bateriju radi uklanjanja.

## Okruženje

---

- Temperatura:
    - Radna: 5°C do 35°C
    - Pohrana: -20°C do 65°C
  - Vlažnost (nekondenzirajuća):
    - Radna: 20% do 80%
    - Pohrana: 20% do 80%
- 



.....

**Napomena:** Gore navedene specifikacije su samo za referencu.  
Točna konfiguracija vašeg računala ovisi o kupljenom modelu.

**Seria Aspire 5745/5553**

Ghid rapid

© 2010 Toate drepturile rezervate.

Ghid rapid seria Aspire 5745/5553

Prima ediție: 03/2010

Notebook seria Aspire 5745/5553

Numărul modelului: \_\_\_\_\_

Numărul seriei: \_\_\_\_\_

Data achiziției: \_\_\_\_\_

Locul achiziției: \_\_\_\_\_

# Înainte de toate

Dorim să vă mulțumim pentru că ați ales un computer portabil Acer pentru a răspunde nevoilor dvs privind un computer mobil.

## Ghidurile dumneavoastră

Pentru a vă ajuta să folosiți computerul portabil Acer, am conceput un set de ghiduri:

Primul dintre acestea, posterul **Doar pentru începători...** vă ajută să porniți cu configurarea computerului.

**Ghidul general de utilizare pentru seria Aspire** conține informații utile valabile pentru toate modelele din gama Aspire. Acoperă subiecte cum ar fi folosirea tastaturii, a sistemului audio etc. Vă rugăm să rețineți că **Ghidul general de utilizare**, precum și **Ghidul utilizatorului AcerSystem (AcerSystem User Guide)** menționat mai jos au fost concepute de așa natură încât să se refere ocazional la funcții sau caracteristici care sunt incluse doar în anumite modele ale seriei și nu neapărat în modelul cumpărat de dumneavoastră. Astfel de cazuri sunt marcate în manuale prin texte cum ar fi "doar pentru anumite modele".

**Ghid rapid** vă prezintă caracteristicile și funcțiile de bază ale noului dvs. computer. Pentru mai multe informații privind modul în care computerul vă poate ajuta să fiți mai productiv, consultați **Ghidul utilizatorului AcerSystem (AcerSystem User Guide)**. Acest ghid conține informații detaliate despre astfel de subiecte, precum utilizările de sistem, recuperarea datelor, opțiunile de extensie și depanarea. În plus, acesta conține informații despre garanție, reglementări generale și note de siguranță pentru computerul dvs portabil. Este disponibil în Format de document portabil (PDF) și vine preîncărcat pe computerul dvs. portabil. Urmați acești pași pentru a-l accesa:

- 1 Faceți clic pe  **Pornire > Toate programele > AcerSystem.**
- 2 Faceți clic pe **Ghidul utilizatorului AcerSystem (AcerSystem User Guide).**



.....

**Notă:** Vizualizarea fișierului necesită Adobe Reader. Dacă Adobe Reader nu este instalat pe computerul dvs., faceți clic pe **Ghidul utilizatorului AcerSystem (AcerSystem User Guide)** și se va executa mai întâi programul de configurare Adobe Reader. Urmați instrucțiunile de pe ecran pentru a încheia instalarea. Pentru instrucțiuni privind modul de utilizare a Adobe Reader, accesați meniul **Ajutor și asistență**.







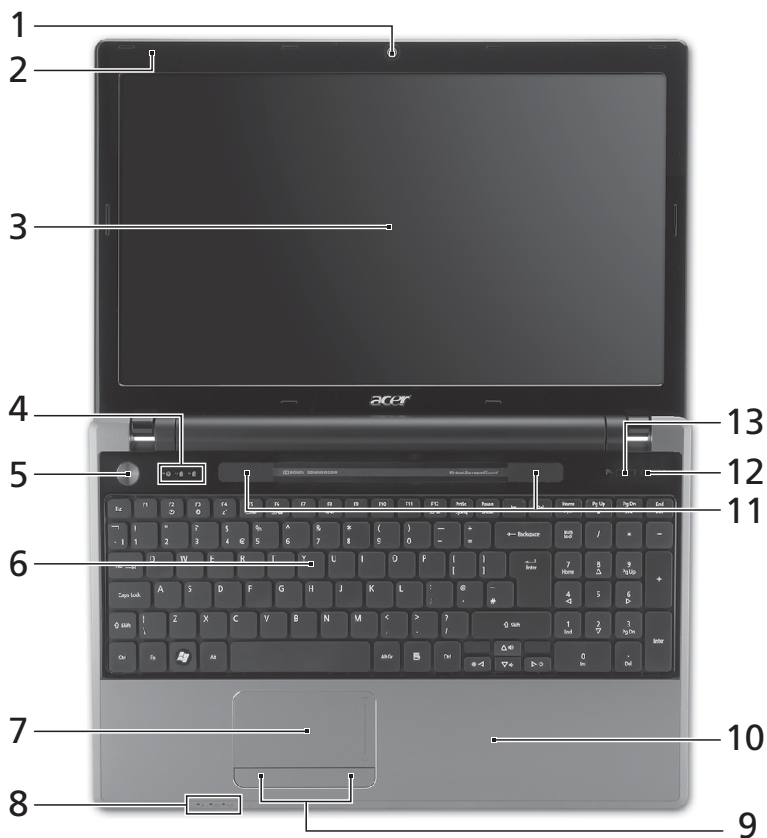

# Turul computerului dvs Acer

După configurarea computerului, așa cum se arată în afișul, permiteți-ne să vă prezentăm computerul portabil Acer.

## Vedere de sus



#	Pictogramă	Element	Descriere
1		Cameră web Acer Crystal Eye	Cameră Web pentru comunicare video (doar pentru anumite modele).
2		Microfon	Microfon intern pentru înregistrarea sunetului.















#	Pictogramă	Element	Descriere
3		Ecraan de afișaj	Mai este numit și Afișaj cu cristale lichide (LCD) și afișează activitatea computerului (configurația poate diferi în funcție de model).
4		Indicator HDD	Indică atunci când unitatea de disc este activă.
		Indicator Num Lock	Se aprinde când Num Lock este activată.
		Indicator Caps Lock	Se aprinde când Caps Lock este activată.
5		Buton Pornire	Pornește și oprește computerul.
6		Tastatură	Pentru introducerea datelor în computer.
7		Zona tactilă	Dispozitiv de indicare sensibil la atingere care funcționează ca un maus de computer.
8		Indicator de alimentare cu energie <sup>1</sup>	Indică nivelul de alimentare cu energie al computerului.
		Indicator baterie <sup>1</sup>	Indică starea bateriei computerului. <b>1. Încărcare:</b> Lumina este galbenă când acumulatorul se încarcă. <b>2. Complet încărcat:</b> Lumina este albastre în modul c.a.
		Indicator comunicare <sup>1</sup>	Indică starea dispozitivului de conectare wireless.
9		Butoane clic (stânga și dreapta)	Butoanele stânga și dreapta funcționează ca butoanele stânga și dreapta ale mausului.
10		Placă pentru sprijinirea palmei	Zonă confortabilă de sprijin pentru mână atunci când folosiți computerul.
11		Difuzoare	Difuzoarele din stânga și dreapta redau sunetul stereo.
12		Buton de eliminare unitate optică	Elimină discul optic din unitate.
13		Tastă programabilă	Programabile de către utilizator (doar pentru anumite modele).
		Tasta PowerSmart	Activează modul de economisire a energiei (doar pentru anumite modele).

1. Indicatoarele de pe panoul frontal sunt vizibile chiar și când capacul computerului este închis.

## Taste rapide

Computerul folosește tastele rapide sau combinațiile de taste pentru a accesa majoritatea comenzilor precum luminozitatea ecranului și volumul.

Pentru a activa tastele rapide, apăsați și mențineți tasta <Fn> înainte de a apăsa cealaltă tastă din combinația de tastă rapidă.

Tastă rapidă	Pictogramă	Funcție	Descriere
<Fn> + <F3>		Tastă pentru comunicații	Activează/dezactivează dispozitivele de comunicație ale computerului (Dispozitivele de comunicație pot diferi în funcție de model).
<Fn> + <F4>		Hibernare	Pune computerul în modul Hibernare.
<Fn> + <F5>		Comutare afișaj	Comută între ecranul notebook-ului și un monitor extern (dacă este conectat), sau ambele.
<Fn> + <F6>		Oprire afișaj	Oprește lumina de fundal a ecranului pentru a economisi energie. Apăsați orice tastă pentru reveni.
<Fn> + <F7>		Comutare zonă de atingere	Activează și dezactivează zona de atingere.
<Fn> + <F8>		Comutare difuzor	Pornește și oprește difuzoarele.
<Fn> + <D>		Luminozitate mărită	Mărește luminozitatea afișajului.
<Fn> + <D>		Luminozitate scăzută	Reduce luminozitatea afișajului.
<Fn> + <Δ>		Volum mărit	Mărește volumul sunetului.
<Fn> + <▽>		Volum scăzut	Reduce volumul sunetului.
<Fn> + <Home>		Redare/Pauză	Redă sau oprește temporar fișierul media selectat.
<Fn> + <Pg Up>		Oprire	Oprește redarea fișierului media selectat.
<Fn> + <Pg Dn>		Anterior	Revine la fișierul media anterior.
<Fn> + <End>		Următor	Trece la următorul fișier media.



## Vedere din față de aproape



#	Pictogramă	Element	Descriere
1		Cititor de cartele multi-in-1	<p>Acceptă carduri Secure Digital (SD), MultiMediaCard (MMC), Memory Stick (MS), Memory Stick PRO (MS PRO) și xD-Picture Card.</p> <p><b>Notă:</b> Apăsăți pentru a extrage/a instala cardul. Nu poate fi citit decât un singur card o dată.</p>







## Vedere din dreapta

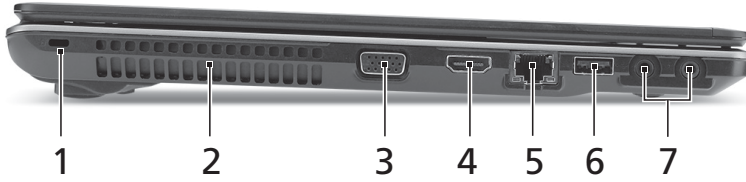

#	Pictogramă	Element	Descriere
1		Port USB 2.0	Conectează la dispozitivele USB 2.0 (de ex. maus USB, cameră USB).
2		Unitate optică	Unitate optică internă, acceptă CD-uri sau DVD-uri.
3		Indicator de acces la discul optic	Se aprinde când unitatea optică este activă.
4		Orificiu de eliminare de urgență	<p>Elimină tava unității optice când computerul este oprit.</p> <p><b>Notă:</b> Introduceți o bucată de hârtie în orificiul de eliminare de urgență pentru a elimina tava unității optice când computerul este oprit.</p>
5		Mufă c.c. intrare	Conectează la un adaptor de c.a.





## Vedere din stânga

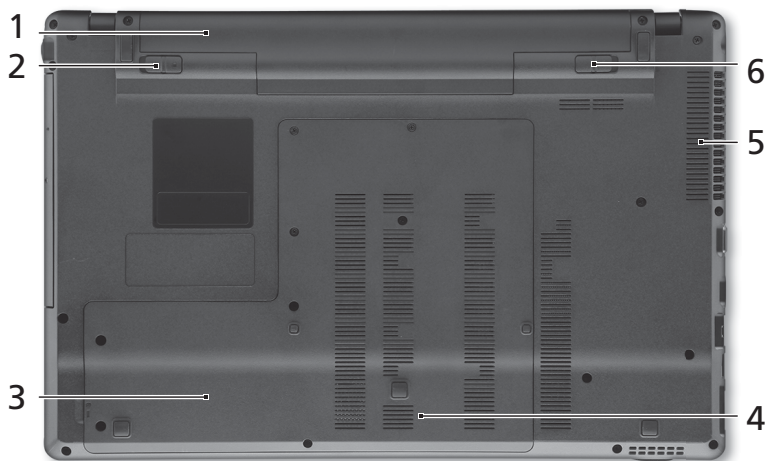

#	Pictogramă	Element	Descriere
1		Slot de blocare Kensington	Conectează la un dispozitiv de securitate pentru computer compatibil Kensington.
2		Orificii de aerisire	Permit computerului să rămână rece, chiar și după utilizarea prelungită.
3		Port pentru afișaj extern (VGA)	Conectează la un dispozitiv de afișare (de ex. monitor extern sau proiector LCD).
4		Port HDMI	Acceptă conexiuni video digitale de înaltă definiție.
5		Port Ethernet (RJ-45)	Conectează la o rețea Ethernet 10/100/1000.
6		Port USB 2.0	Conectează la dispozitivele USB 2.0 (de ex. maus USB, cameră USB).
7		Mufă microfon	Acceptă intrări de la microfoane externe.
		Port de căști/difuzor/mufă de ieșire cu suport S/PDIF	Conectează la dispozitivele audio de ieșire (de ex. difuzoare, căști).

## Vedere bază



#	Pictogramă	Element	Descriere
1		Nișă pentru baterie	Adăpostește bateria computerului.
2		Blocaj baterie	Blochează bateria în poziție.
3		Nișă unitate de harddisc	Adăpostește unitatea harddisc a computerului (fixată cu șuruburi).
4		Compartiment memorie	Adăpostește memoria principală a computerului.
5		Orificii de ventilație și ventilator de răcire	Permit computerului să rămână rece, chiar și după utilizarea prelungită. <b>Notă:</b> Nu acoperiți sau obstrucționați deschiderea ventilatorului.
6		Zăvor de eliberare a bateriei	Eliberează bateria pentru a fi scoasă.

## Mediu

---

- Temperatură:
    - Funcționare: 5°C - 35°C
    - Nefuncționare: -20°C - 65°C
  - Umiditate (fără condens):
    - Funcționare: 20% - 80%
    - Nefuncționare: 20% - 80%
- 



.....

**Notă:** Specificațiile enumerate mai sus sunt numai pentru referință.  
Configurația exactă a computerului depinde de modelul achiziționat.

# Серия *Aspire* 5745/5553

Кратко ръководство

© 2010 Всички права запазени.

Кратко ръководство за Серия Aspire 5745/5553

Първоначално издание: 03/2010

Серия Aspire 5745/5553 Персонален ноутбук

Модел номер: \_\_\_\_\_

Сериен номер: \_\_\_\_\_

Дата на закупуване: \_\_\_\_\_

Място на закупуване: \_\_\_\_\_

# Преди всичко

Бихме желали да ви благодарим, че сте избрали ноутбук на Асер за вашите нужди в областта на мобилните компютри.

## Вашите ръководства

За да ви помогнем при употребата на вашия ноутбук Асер, ние изготвихме следните ръководства:

Първо, постерът **Като за начало...** ви помага с началните настройки на компютъра ви.

**Универсалното потребителско ръководство за серията *Aspire*** съдържа полезна информация, валидна за всички модели от продуктовата серия *Aspire*. Покрива основни теми като използване на клавиатурата, аудио и др. Важно е да знаете, че поради обошаващия си характер, **Универсалното потребителско ръководство**, както и упоменатото по-долу **Потребителско ръководство *AcerSystem* (*AcerSystem User Guide*)**, на места разглеждат функции и възможности, които са налични само за конкретни модели от сериите, без това да означава, че са налични за модела, който сте закупили. Тези случаи са отбелязани в текста със забележки като „само за някои модели“.

**Кратко ръководство** ви представя основните функции и възможности на новия ви компютър. За повече информация как вашият компютър може да ви помогне да сте по-продуктивни, моля вижте **Потребителското ръководство *AcerSystem* (*AcerSystem User Guide*)**. То съдържа подробна информация за теми като системни инструменти, възстановяване на данни, опции за ъпгрейд и решаване на проблеми. В допълнение, то съдържа и гаранционна информация, както и основните регулации и бележки за безопасност, свързани с вашия ноутбук. То е в PDF формат (Portable Document Format) и е предварително заредено на ноутбука ви. За да го отворите, следвайте тези стъпки:

- 1 Кликнете  **Старт > Всички програми > *AcerSystem***.
- 2 Кликнете **Потребителско ръководство *AcerSystem* (*AcerSystem User Guide*)**.



-----

**Бележка:** За да отворите файла ви е нужен Adobe Reader. Ако Adobe Reader не е инсталиран на компютъра ви, когато кликнете върху **Потребителско ръководство *AcerSystem* (*AcerSystem User Guide*)**, ще се стартира инсталационната програма на Adobe Reader. Следвайте инструкциите на екрана, за да извършите инсталацията. За инструкции как се използва Adobe Reader, отворете менюто **Help and Support**.

# Преглед на Вашия ноутбук Асер





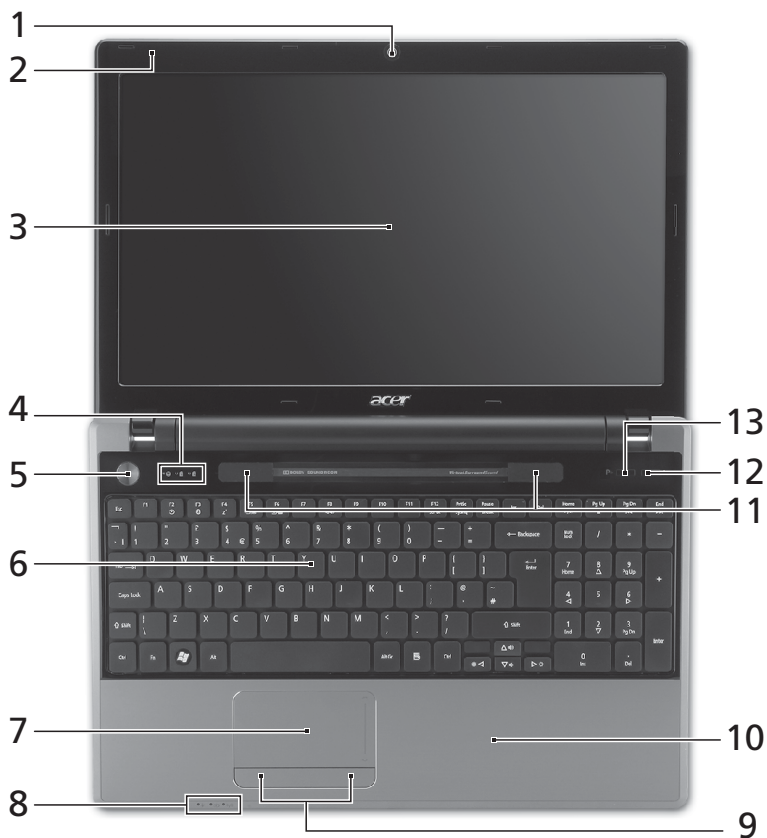

След като настроите компютъра си, както е показано в постера, ще ви покажем какво прави и какво има вашият нов ноутбук Асер.

## Изглед отгоре



#	Икона	Обект	Описание
1		Уеб камера Acer Crystal Eye	Уеб камера за видео комуникации (само за някои модели).
2		Микрофон	Вграден микрофон за запис на звук.



#	Икона	Обект	Описание
3		Дисплей	Нарича се още "Течнокристален дисплей" (LCD) и е екранът на компютъра (конфигурацията може да се различава в зависимост от моделите).
4		Индикатор на твърдия диск	Посочва дали твърдият диск е активен.
		Num Lock индикатор	Светва, когато активирате Num Lock.
		Caps Lock индикатор	Светва, когато активирате Caps Lock.
5		Бутон за захранване	С него компютърът се включва и изключва.
6		Клавиатура	Служи за въвеждане на данни в компютъра Ви.
7		Тъчпад	Чувствително на допир посочващо устройство, което функционира като компютърна мишка.
8		Индикатор на захранването <sup>1</sup>	Показва статуса на захранване на компютъра.
		Индикатор за нивото на батерията <sup>1</sup>	Посочва статуса на батерията на компютъра. <b>1. Зареждане:</b> Индикаторът свети в жълто, докато батерията се зарежда. <b>2. Напълно заредена:</b> Индикаторът свети в синьо, когато сте в режим AC.
		Индикатор за комуникации <sup>1</sup>	Посочва статуса на устройството за безжична връзка на компютъра.
9		Бутони за кликуване (ляв и десен)	Левият и десният бутони функционират като ляв и десен бутон на мишка.
10		Подложка за длани	Удобно място, на което да поставите ръцете си, когато използвате компютъра.
11		Високоговорители	Ляв и десен високоговорител за стерео аудио възпроизвеждане.
12		Бутон за отваряне на оптичното устройство	Изважда оптичния диск от устройството.
13	<b>P</b>	Програмируем клавиш	Програмируемо от потребителя (само за някои модели).
		PowerSmart клавиш	Включва икономичен режим за компютъра (само за някои модели).

1. Индикаторите на предния панел остават видими дори когато капакът на компютъра е затворен.

## Горещи клавиши

Компютърът има "горещи клавиши" - клавишни комбинации за бърз достъп до повечето от контролите му, като например яркост на дисплея и сила на звук.

За да активирате горещите клавиши, натиснете и задръжте върху клавиша <Fn> преди да натиснете другия клавиш от комбинацията.

Горещ клавиш	Икона	Функция	Описание
<Fn> + <F3>		Клавиш за комуникации	Включва/изключва устройствата за комуникация на компютъра (Устройствата за комуникация може да варират според конфигурацията).
<Fn> + <F4>		Заспиване	Вкарва компютъра в режим "Заспиване".
<Fn> + <F5>		Превключване на дисплей	Превключва активния дисплей между екрана, външния монитор (ако е свързан такъв), или и двете.
<Fn> + <F6>		Изкл. дисплей	Изключва задното осветление на екрана, за да пести енергия. Натиснете който и да е клавиш, за да го включите отново.
<Fn> + <F7>		Превключване на тъчпада	Включва и изключва вътрешния тъчпад.
<Fn> + <F8>		Превключване на високоговорителите	Включва и изключва високоговорителите.
<Fn> + <D>		Засилване на яркостта	Увеличава яркостта на екрана.
<Fn> + <A>		Намаляване на яркостта	Намалява яркостта на екрана.
<Fn> + <V>		Засилване на звука	Усилва силата на звука.
<Fn> + <W>		Намаляване на звука	Намалява силата на звука.
<Fn> + <Home>		Възпроизвеждане/ Пауза	Възпроизвеждане или пауза за избрания мултимедиен файл.
<Fn> + <Pg Up>		Стоп	Спира възпроизвеждането на избрания мултимедиен файл.
<Fn> + <Pg Dn>		Предишен	Връщане към предишен мултимедиен файл.
<Fn> + <End>		Следващ	Прескачане до следващия мултимедиен файл.

## Преден изглед при затворен лаптоп



#	Икона	Обект	Описание
1		Четец на карти Много-в-1	Чете Secure Digital (SD), MultiMediaCard (MMC), Memory Stick (MS), Memory Stick PRO (MS PRO) и xD Picture Card (xD). <b>Забележка:</b> Натиснете, за да извадите/ деинсталирайте картата. Само една карта може да работи едновременно.

## Изглед отдясно



#	Икона	Обект	Описание
1		USB 2.0 порт	За връзка с USB 2.0 устройства (напр. USB мишки, USB камери).
2		Оптично устройство	Вътрешно оптично устройство; чете CD или DVD.
3		Индикатор за достъп до оптичен диск	Светва, когато оптичното устройство е активно.
4		Дупка за спешно изваждане	Вади оптичния диск, когато компютъра е изключен. <b>Забележка:</b> Пъхнете кламер в дупката за спешно изваждане, за да извадите подноса на оптичното устройство, докато компютъра е изключен.
5		Жак за DC вход	За връзка с AC адаптер.



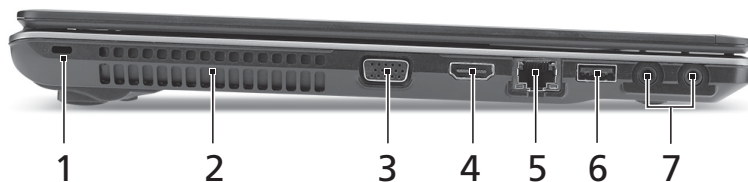

## Изглед отляво

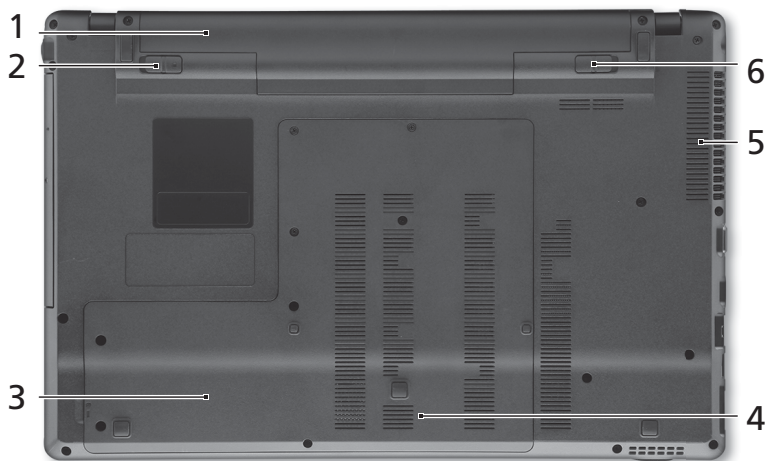

#	Икона	Обект	Описание
1		Слот за заключващ механизъм Kensington	За връзка с Kensington-съвместим компютърен заключващ механизъм.
2		Вентилационни отвори	Позволява на компютъра да се охлажда дори и при продължителна употреба.
3		Порт за външен дисплей (VGA)	За връзка с дисплейно устройство (напр. външен монитор, LCD проектор).
4		HDMI порт	Поддържа цифрови видео връзки с висока разделителна способност.
5		Порт за Ethernet (RJ-45)	За връзка с мрежа, базирана на Ethernet 10/100/1000.
6		USB 2.0 порт	За връзка с USB 2.0 устройства (напр. USB мишки, USB камери).
7		Жак за микрофон	Приема вход от външни микрофони.
		Жак за слушалки/колони/изход с поддръжка на S/PDIF	За връзка с изходни аудио устройства (напр. колони, слушалки).

## Изглед отдолу



#	Икона	Обект	Описание
1		Отделение за батерия	Тук се поставя батерияният пакет на компютъра.
2		Придържателен механизъм на батерията	Държи батерията на мястото ѝ.
3		Отделение за твърдия диск	Тук стои твърдият диск на компютъра (прикрепен с винтове).
4		Отделение за памет	Тук се поставя главната памет на компютъра.
5		Вентилационни слотове и охлаждащ вентилатор	Позволява на компютъра да се охлажда дори и при продължителна употреба. <b>Забележка:</b> Не покривайте и не препречвайте отвора на вентилатора.
6		Езиче за освобождаване на батерията	Освобождава батерията, за да можете да я извадите.

## Работна среда

---

- Температура:
    - Работна: 5°C до 35°C
    - За съхранение: -20°C до 65°C
  - Влажност (некондензирана):
    - Работна: 20% до 80%
    - За съхранение: 20% до 80%
- 



.....

**Забележка:** Спецификациите, изброени по-горе, са само за справка. Точната конфигурация на вашия компютър зависи от това кой модел сте закупили.

# Aspire 5745/5553 seeria

Lühijuhend

© 2010 Kõik õigused kaitstud.

Aspire 5745/5553 seeria lühijuhend  
Originaalväljaanne: 03/2010

Aspire 5745/5553 seeria sülearvuti

Mudeli number: \_\_\_\_\_

Seerianumber: \_\_\_\_\_

Ostukuupäev: \_\_\_\_\_

Ostukoht: \_\_\_\_\_



# Kõigepealt tähtsamad asjad

Täname Teid selle eest, et valisite oma kaasaskantavaks arvutiks Acer'i sülearvuti.

## Teie teejuhid

Et aidata Teil kasutada oma Acer'i sülearvutit, oleme loonud komplekti juhiseid:

Kõigepealt aitab poster **Alustuseks...** Teil alustada oma arvuti häälestamist.

**Aspire seeria üldkasutusjuhend** sisaldab kõigile Aspire tooteseeria mudelitele kohalduvat kasulikku teavet. See katab põhilisi teemasid nagu klaviatuuri kasutamine, heli jne. Palume mõista, et tulenevalt nende loomusest viitavad nii **Üldkasutusjuhend** kui ka allpool mainitud **AcerSystemi kasutaja teatmik (AcerSystem User Guide)** aeg-ajalt funktsioonidele või omadustele, mis on ainult teatud seeria mudelitel, kuid mitte tingimata teie ostetud mudelil. Sellised juhtumid on tekstis märgitud väljenditega nagu „ainult teatud mudelitel“.

**Lühijuhend** tutvustab Teile uue arvuti põhilisi omadusi ja funktsioone. Kui soovite saada rohkem teada sellest, kuidas arvuti Teil aitab produktiivsem olla, vaadake **AcerSystemi kasutaja teatmik (AcerSystem User Guide)**. Teatmik sisaldab täpsemat informatsiooni teemadel nagu süsteemiütiilidid, andmete taastamine, laiendusvõimalused ja probleemide lahendamine. Sellele lisaks sisaldab see garantiinformatsiooni ning sülearvuti kohta kehtivaid üldiseid regulatsioone ja ohutuseeskirju. See on saadaval PDF-formaadis (Portable Document Format) ning on laetud Teie sülearvutisse. Juhised selle avamiseks:

- 1 Klõpsake ja avage  **Start > Kõik programmid > AcerSystem.**
- 2 Klõpsake real **AcerSystemi kasutaja teatmik (AcerSystem User Guide).**



-----

**Märkus:** Faili vaatamiseks on vaja Adobe Reader'it. Kui Adobe Reader pole arvutisse installeeritud, käivitab **AcerSystemi kasutaja teatmik (AcerSystem User Guide)** 'ile kõigepealt Adobe Reader'i installeerimisprogrammi. Installeerimise lõpetamiseks järgige ekraanil olevaid juhiseid. Juhiseid Adobe Reader'i kasutamiseks leiate menüüst **Spikker ja tugi**.







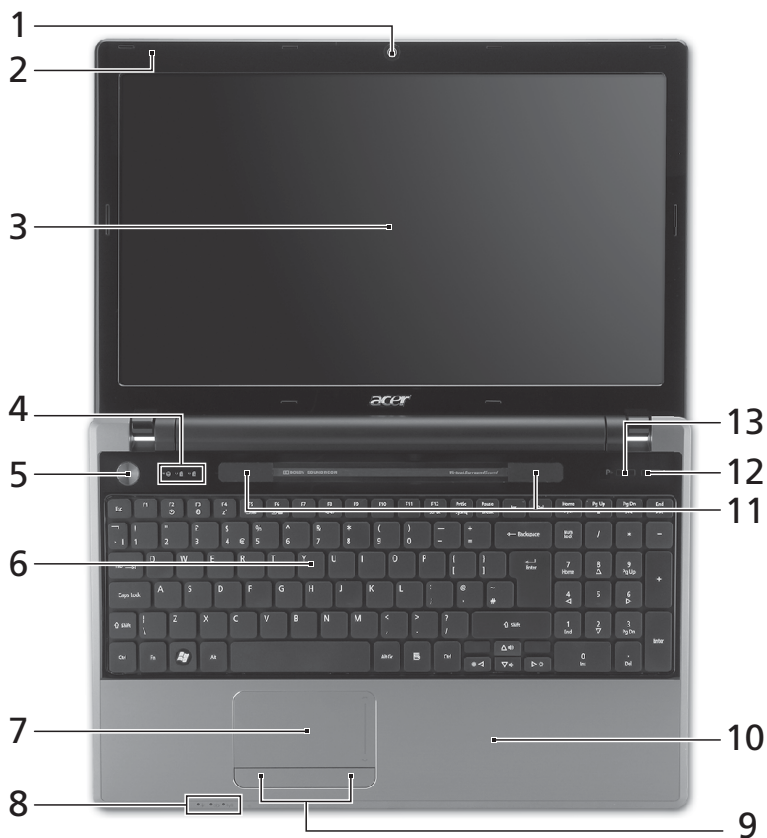

# Teie Acer sülearvuti ülevaade

Kui olete oma arvuti häälestanud postril kujutatud viisil, lubage meil teile tutvustada teie uut Acer sülearvutit.

## Pealtvaade



#	Ikoon	Objekt	Kirjeldus
1		Acer Crystal Eye veebikaamera	Veebikaamera videosuhtluseks (ainult teatud mudelitel).
2		Mikrofon	Sisseehitatud mikrofon heli salvestamiseks.















#	Ikoon	Objekt	Kirjeldus
3		Kuvariekraan	Teise nimega vedelkristallekraan (LCD), kuvab arvuti pilti (Mudelite konfiguratsioon võib erineda).
4		Kõvakettaindikaator	Näitab kõvaketta aktiivsust.
		Numbrilukuindikaator	Sütib siis, kui numbrilukk aktiveeritakse.
		Suurtähelukuindikaator	Sütib siis, kui suurtähelukk aktiveeritakse.
5		Voolunupp	Arvuti sisse- ja väljalülitamiseks.
6		Klaviatuur	Andmete sisestamiseks arvutisse.
7		Puuteplaat	Puutetundlik osutusseadis, mis töötab arvutihirena.
8		Vooluindikaator <sup>1</sup>	Näitab arvuti olekut.
		Akuindikaator <sup>1</sup>	Näitab arvuti aku olekut. <b>1. Laadimine:</b> kui akut laetakse, on tuli kollakat värvi. <b>2. Täielikult laetud:</b> kui arvuti on vooluvõrgus, on tuli sinist värvi.
		Ühenduse indikaator <sup>1</sup>	Näitab arvuti traadita ühenduse seadme olekut.
9		Klõpsunupud (vasem ja parem)	Vasak ja parem nupp funktsioneerivad vasaku ja parema hiirenupuna.
10		Randmetugi	Mugav toetusala, kuhu saate arvutit kasutades toetada oma käsi.
11		Kõlarid	Vasak- ja parempoolne kõlar, toodavad stereoheli.
12		Optilise seadme väljastusnupp	Väljastab optilise ketta seadmest.
13	<b>P</b>	Seadistatav klahv	Kasutaja poolt seadistatav (ainult teatud mudelitel).
		PowerSmart-klahv	Lülitab arvuti energiasäästurežiimile (ainult teatud mudelitel).

1. Esipaneelil asuvad indikaatorid on nähtavad ka siis, kui arvuti kaas on suletud.

## Kiirklahvid

Arvutil on enamiku seadete jaoks (nt ekraani heledus, heliväljund) olemas kiirklahvid ja klahvikombinatsioonid.

Kiirklahvide aktiveerimiseks vajutage ning hoidke enne teise kombinatsiooni kuuluva klahvi vajutamist all klahvi **<Fn>**.

Kiirklahv	Ikon	Funktsioon	Kirjeldus
<Fn> + <F3>		Sideklahv	Aktiveerib/desaktiveerib arvuti sideseamded (Sideseadmed võivad vastavalt konfiguratsioonile erineda).
<Fn> + <F4>		Unerežiim	Lülitab arvuti unerežiimi.
<Fn> + <F5>		Ekraani valik	Lülitab ekraanipildi kuvaekraanile, välisele ekraanile (kui see on ühendatud) või mõlemale.
<Fn> + <F6>		Ekraan välja	Lülitab ekraani tagantvalgustuse energia säästmiseks välja. Tagasipöördumiseks vajutage suvalisele klahvile.
<Fn> + <F7>		Puuteplaadi lüliti	Lülitab integreeritud puuteplaadi sisse või välja.
<Fn> + <F8>		Kõlarilüliti	Lülitab kõlarid sisse või välja.
<Fn> + <▷>		Heledus üles	Suurendab ekraani heledust.
<Fn> + <◁>		Heledus alla	Vähendab ekraani heledust.
<Fn> + <△>		Helitugevus üles	Tõstab helitugevust.
<Fn> + <▽>		Helitugevus alla	Langetab helitugevust.
<Fn> + <Home>		Esita/paus	Esitab või peatab valitud meediumifaili.
<Fn> + <Pg Up>		Lõpeta	Lõpetab valitud meediumifaili esitamise.
<Fn> + <Pg Dn>		Eelmine	Pöördub tagasi eelmise meediumifaili juurde.
<Fn> + <End>		Järgmine	Liigub edasi järgmise meediumifaili juurde.

## Suletud eestvaade



#	Ikoon	Objekt	Kirjeldus
1		Mitu-ühes kaardilugeja	Võtab vastu Secure Digital (SD), MultiMediaCard (MMC), Memory Stick (MS), Memory Stick PRO (MS PRO) ja xD-Picture kaarte (xD). <b>Märkus:</b> Kaardi eemaldamiseks/ paigaldamiseks vajutage sellele. Korraga saab töötada ainult üks kaart.







## Vaade paremalt

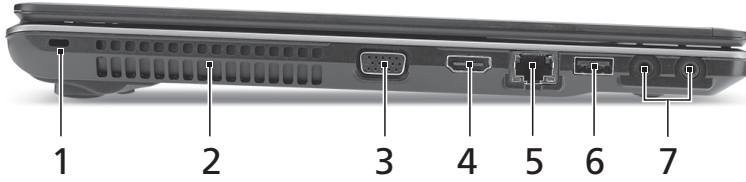

#	Ikoon	Objekt	Kirjeldus
1		USB 2.0 port	USB 2.0 seadmete ühendamiseks (nt USB-hiir või USB-kaamera).
2		Optiline seade	Sisemine optiline seade; loeb CD-sid või DVD-sid.
3		Optilise ketta lugemise indikaator	Süttib, kui optiline seade on aktiivne.
4		Hädaväljastusava	Avab optilise seadme sahtli, kui arvuti on välja lülitatud. <b>Märkus:</b> Optilise seadme avamiseks siis, kui arvuti on välja lülitatud, lükake hädaväljastusavasse kirjaklamber.
5		Alalisvoolusisendi pistik	Vahelduvvooluadapteri (toiteploki) ühendamiseks.



## Vaade vasakult

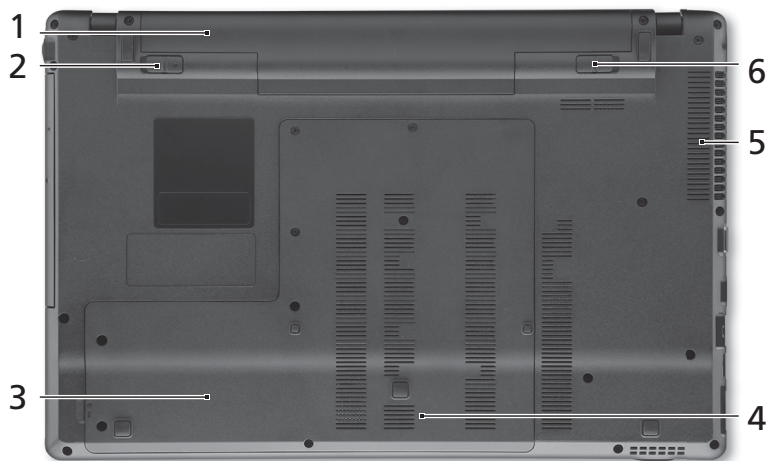

#	Ikon	Objekt	Kirjeldus
1		Kensington-luku pesa	Kensington-tüüpi arvuti turvaluku ühendamiseks.
2		Ventilatsiooniavad	Võimaldavad arvutil püsida jahedana ka pärast pikaajalist kasutamist.
3		Välisekraani (VGA) port	Kuvaseadme (nt välise monitori või LCD-projektori) ühendamiseks.
4		HDMI-port	Toetab kõrglahutusega digitaalvideoühendusi.
5		Etherneti (RJ-45) port	Ethernet 10/100/1000-põhise võrguga ühendamiseks.
6		USB 2.0 port	USB 2.0 seadmete ühendamiseks (nt USB-hiir või USB-kaamera).
7		Mikrofonisisend	Võtab vastu sisendheli välisest mikrofonist.
		Kõrvaklappide/ kõlarite/heliväljundi pistik S/PDIF toega	Heliväljundseadmete ühendamiseks (nt kõlarid, kõrvaklapid).

## Põhjavaade



#	Ikoon	Objekt	Kirjeldus
1		Akusektsioon	Siin asuvad arvuti akud.
2		Akulukk	Lukustab aku kohale.
3		Kõvakettasektsioon	Siin asub arvuti kõvaketas (kinnitatud kruvidega).
4		Mälusahtel	Siin asub arvuti põhimälu.
5		Ventilatsiooniavad ning jahutusventilaator	Võimaldavad arvutil püsida jahedana ka pärast pikaajalist kasutamist. <b>Märkus:</b> Ärge katke või blokeeri ventilatsiooni avasid.
6		Aku vabastamise riiv	Vabastab aku, et seda saaks välja võtta.

## Keskkond

---

- Temperatuur:
    - Töötamiseks sobiv: 5°C kuni 35°C
    - Sobimatu: -20°C kuni 65°C
  - Niiskus (mittekondenseeruv):
    - Töötamiseks sobiv: 20% kuni 80%
    - Sobimatu: 20% kuni 80%
- 



.....

**Märkus:** Toodud spetsifikatsioonid on ainult võrdlusaineks.  
Arvuti täpne konfiguratsioon sõltub ostetud mudelist.



# Aspire 5745/5553 sērija

Ātrais ceļvedis

© 2010 Visas tiesības aizsargātas.

Aspire 5745/5553 sērijas ātrais ceļvedis

Orģinālizdevums: 03/2010

Aspire 5745/5553 sērijas piezīmjdators

Modeļa numurs: \_\_\_\_\_

Sērijas numurs: \_\_\_\_\_

Pirkuma datums: \_\_\_\_\_

Pirkuma vieta: \_\_\_\_\_

# Galvenais vispirms

Mēs vēlamies jums pateikties, ka esat izvēlējies Acer piezīmjdatoru, lai nodrošinātu savas mobilās skaitļošanas vajadzības.

## Jūsu rokasgrāmatas

Lai palīdzētu jums lietot Acer piezīmjdatoru, esam sagatavojuši rokasgrāmatu komplektu:

Pirmkārt, plakāts **Tikko sākušajiem...** jums palīdz uzsākt datora iestatīšanu.

**Aspire sērija vispārējais lietotāja ceļvedis** satur noderīgu informāciju, kas attiecas uz visiem Aspire produktu sērijas modeļiem. Tas aptver pamata tematiku, tādu kā tastatūras un audio izmantošana utt. Lūdzu, saprotiet, ka **vispārējais lietotāja ceļvedis**, kā arī **AcerSystem lietotāja ceļvedis (AcerSystem User Guide)**, kas pieminēts turpmāk, to būtības dēļ laiku pa laikam attiecas uz funkcijām vai līdzekļiem, kas piemīt tikai noteiktiem sērijas modeļiem, bet ne obligāti modelim, ko esat iegādājies. Šādi gadījumi tekstā ir apzīmēti ar vārdiem „tikai noteiktiem modeļiem”.

**Ātrais ceļvedis** sniedz ieskatu par jūsu jaunā datora galvenajiem līdzekļiem un funkcijām. Lai uzzinātu vairāk, kā jūsu dators jums var palīdzēt būt vēl produktīvākam, lūdzu, skatiet **AcerSystem lietotāja ceļvedis (AcerSystem User Guide)**. Šajā ceļvedī ir detalizēta informācija par tādām tēmām kā sistēmas utilitās, datu atkopšana, paplašināšanas opcijas un problēmu novēršana. Bez tam tajā ir iekļauta informācija par garantijām un piezīmjdatora lietošanas vispārīgas regulas un drošības paziņojumi. Tas ir pieejams PDF (Portable Document Format - portatīvā dokumenta formāts) formātā un ir iepriekš ielādēts jūsu piezīmjdatorā. Veiciet šīs darbības, lai tam piekļūtu:

- 1 Noklikšķiniet uz  **Start (Sākt) > All Programs (Visas programmas) > AcerSystem.**
- 2 Noklikšķiniet uz **AcerSystem lietotāja ceļvedis (AcerSystem User Guide).**





**Piezīme:** Lai skatītu failu, nepieciešama programma Adobe Reader. Ja jūsu datorā nav instalēta programma Adobe Reader, pirmo reizi noklikšķinot uz **AcerSystem lietotāja ceļvedis (AcerSystem User Guide)**, automātiski tiks palaista programmas Adobe Reader instalēšana. Lai pabeigtu instalēšanu, izpildiet ekrānā redzamos norādījumus. Lai iegūtu norādījumus, kā lietot programmu Adobe Reader, piekļūstiet izvēlei **Help and Support (Palīdzība un atbalsts)**.





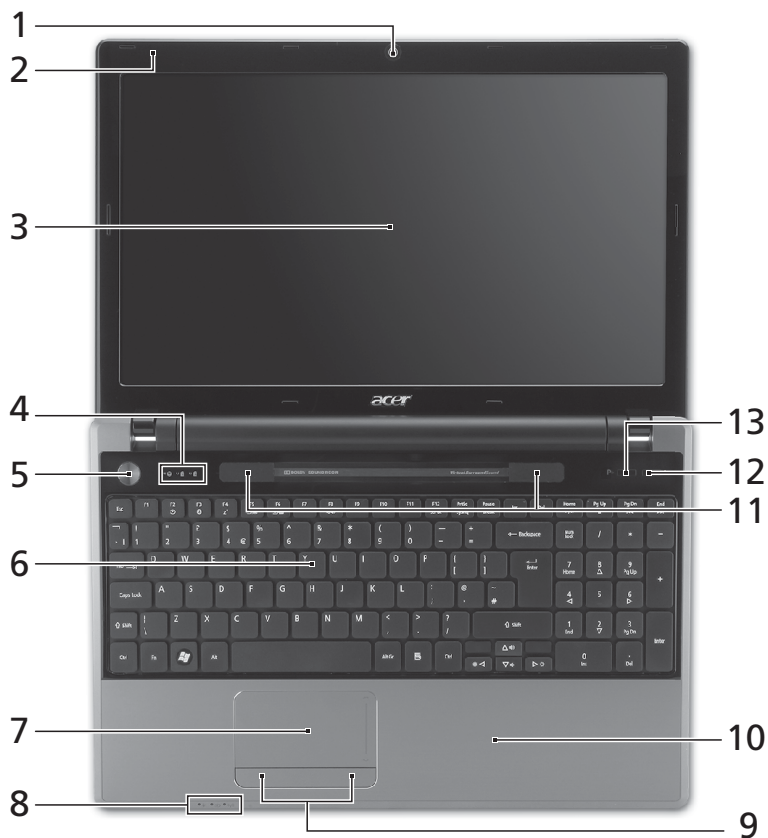



# Acer piezīmjdatora pārskats

Ja esat sagatavojis datoru darbam kā redzams attēlā, ļaujiet mums jūs iepazīstināt ar jūsu jauno Acer piezīmjdatoru.

## Skats no augšpuses



#	Ikona	Elements	Apraksts
1		Acer Crystal Eye tīmekļa kamera	Tīmekļa kamera videosakariem (tikai noteiktiem modeļiem).
2		Mikrofons	Iekšējais mikrofons skaņas ierakstīšanai.

#	Ikona	Elements	Apraksts
3		Displeja ekrāns	Saukts arī par šķidro kristālu displeju (LCD); rāda datora izvadi (modeļu konfigurācija var atšķirties).
4		Cietā diska indikators	Norāda, ka cietais disks ir aktīvs.
		Num Lock (Ciparslēgs) indikators	Deg, ja ir aktivizēts ciparslēgs.
		Caps Lock (Burtslēgs) indikators	Deg, ja ir aktivizēts burtslēgs.
5		Barošanas poga	Ieslēdz un izslēdz datoru.
6		Tastatūra	Datu ievadīšanai datorā.
7		Skārienpanelis	Skārienjutīga rādītājiereice, kas darbojas kā datora pele.
8		Barošanas indikators <sup>1</sup>	Norāda datora barošanas statusu.
		Akumulatora indikators <sup>1</sup>	Norāda datora akumulatora statusu. <b>1. Uzlāde:</b> Indikators ir oranžā krāsā, akumulatoram lādējoties. <b>2. Pilnībā uzlādēts:</b> Datoram darbojoties no maiņstrāvas, indikators ir zils.
		Sakarū indikators <sup>1</sup>	Norāda datora bezvadu savienojamās ierīces statusu.
9		Klikšķināmas pogas (kreisā un labā)	Kreisā un labā poga darbojas tāpat kā peles kreisā un labā poga.
10		Plaukstu atbalsta zona	Ērta atbalsta zona jūsu rokām, kad lietojat datoru.
11		Skalruņi	Kreisais un labais skalruņis nodrošina stereo audio izvadi.
12		Optiskā diska izstumšanas poga	Izstumj no diskdziņa optisko disku.
13		Programmējams taustiņš	Lietotājs šo pogu var pārprogrammēt (tikai noteiktiem modeļiem).
		PowerSmart taustiņš	Pārslēdz datoru enerģijas taupīšanas režīmā (tikai noteiktiem modeļiem).

1. Priekšējā paneļa indikatori ir redzami pat tad, kad datora vāks ir aizvērts.

## Ātrie taustiņi

Lai piekļūtu lielākajai daļai datora vadības funkciju, piemēram, ekrāna spilgtuma un skaļuma regulēšanai, tiek izmantoti datora ātrie taustiņi jeb taustiņu kombinācijas.

Lai aktivizētu ātros taustiņus, nospiediet un turiet taustiņu **<Fn>**, tad nospiediet ātrā taustiņa kombinācijas otru taustiņu.

Ātrais taustiņš	Ikona	Funkcija	Apraksts
<b>&lt;Fn&gt; + &lt;F3&gt;</b>		Sakaru taustiņš	Iespējo/atspējo datora sakaru ierīces (Sakaru ierīces var atšķirties atkarībā no konfigurācijas).
<b>&lt;Fn&gt; + &lt;F4&gt;</b>		Miega režīms	Pārslēdz datoru miega režīmā.
<b>&lt;Fn&gt; + &lt;F5&gt;</b>		Displeja pārslēgšana	Pārslēdz displeja izvadi starp displeja ekrāna un ārējo monitoru (ja tas ir pievienots), vai rāda izvadi abos.
<b>&lt;Fn&gt; + &lt;F6&gt;</b>		Izslēgt displeju	Enerģijas taupīšanas nolūkā izslēdz displeja ekrāna pretgaismu. Lai atjaunotu pretgaismu, nospiediet jebkuru taustiņu.
<b>&lt;Fn&gt; + &lt;F7&gt;</b>		Skārienpaneļa pārslēgšana	Ieslēdz un izslēdz iebūvēto skārienpaneli.
<b>&lt;Fn&gt; + &lt;F8&gt;</b>		Skaļruņu pārslēgšana	Ieslēdz un izslēdz skaļruņus.
<b>&lt;Fn&gt; + &lt;▷&gt;</b>		Spilgtāk	Palielina ekrāna spilgtumu.
<b>&lt;Fn&gt; + &lt;◁&gt;</b>		Blīvāk	Samazina ekrāna spilgtumu.
<b>&lt;Fn&gt; + &lt;△&gt;</b>		Skaļāk	Palielina skaņas skaļumu.
<b>&lt;Fn&gt; + &lt;▽&gt;</b>		Klusāk	Samazina skaņas skaļumu.
<b>&lt;Fn&gt; + &lt;Home&gt;</b>		Atskaņot/apturēt	Atskaņo vai aptur izvēlēto multivides failu.
<b>&lt;Fn&gt; + &lt;Pg Up&gt;</b>		Pārtraukt	Aptur izvēlēta multivides faila atskaņošanu.
<b>&lt;Fn&gt; + &lt;Pg Dn&gt;</b>		Atpakaļ	Atgriežas pie iepriekšējā multivides faila.
<b>&lt;Fn&gt; + &lt;End&gt;</b>		Tālāk	Pārlec uz nākamo multivides failu.

## Skats no priekšpuses aizvērtā veidā



#	Ikona	Elements	Apraksts
1		Karšu lasītājs "Vairāki vienā"	Pieņem datu nesējus Secure Digital (SD), MultiMediaCard (MMC), Memory Stick (MS), Memory Stick PRO (MS PRO) un xD-Picture Card (xD). <b>Piezīme:</b> Nospiediet, lai izņemtu/installētu karti. Vienlaikus var lietot tikai vienu karti.







## Skats no labās puses

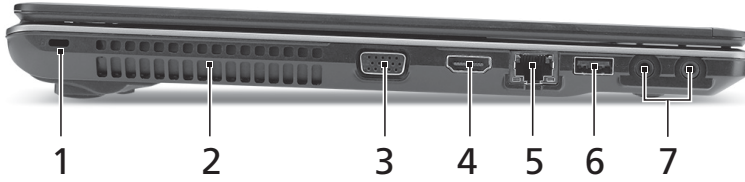

#	Ikona	Elements	Apraksts
1		USB 2.0 ports	Šeit pieslēdz USB 2.0 ierīces (piemēram, USB peli, USB kameru).
2		Optiskais diskdzinis	Iekšējais optiskais diskdzinis; pieņem CD vai DVD diskus.
3		Optiskā diska piekļuves indikators	Iedegas, kad optiskais diskdzinis ir aktīvs.
4		Ārkārtas diska izņemšanas caurums	Izstumj optiskā diskdziņa paliktni, kad dators ir izslēgts. <b>Piezīme:</b> Lai izstumtu optiskā diskdziņa paliktni, kad dators ir izslēgts, iespiediet ārkārtas diska izņemšanas caurumā papīra saspraudi.
5		Līdzstrāvas ieejas ligzda	Šeit pieslēdz maiņstrāvas adapteru.

## Skats no kreisās puses







#	Ikona	Elements	Apraksts
1		Kensington atslēgas slots	Šeit pieslēdz Kensington atslēgu datora drošībai.
2		Ventilācijas atveres	Neļauj datoram sakarst pat pēc ilgstošas lietošanas.
3		Ārējā displeja (VGA) ports	Šeit pieslēdz displeja ierīci (piemēram, ārēju monitoru, LCD projektoru).
4		HDMI ports	Atbalsta augstas kvalitātes ciparu video savienojumus.
5		Ethernet (RJ-45) ports	Šeit pieslēdz Ethernet 10/100/1000 tīkla vadu.
6		USB 2.0 ports	Šeit pieslēdz USB 2.0 ierīces (piemēram, USB peli, USB kameru).
7		Mikrofona ligzda	Pieņem ievadi no ārējiem mikrofoniem.
		Austiņu/skaļruņu/ līnijas izejas ports ar S/PDIF atbalstu	Šeit pieslēdz audio līnijas izejas ierīces (piemēram, skaļruņus, austiņas).

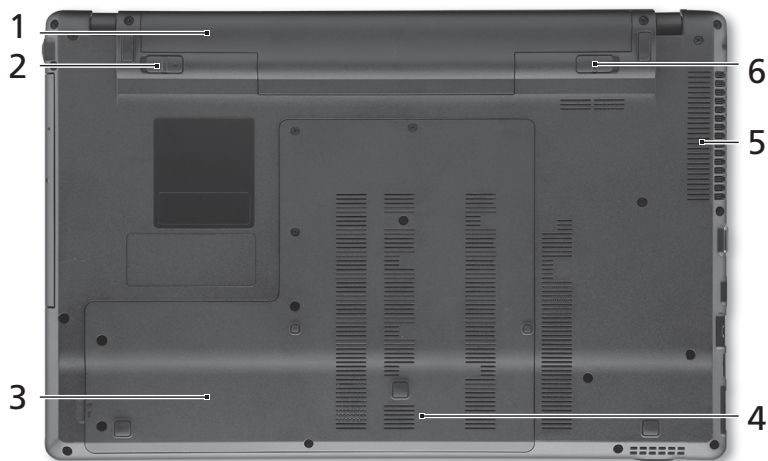

## Skats no apakšpuses



#	Ikona	Elements	Apraksts
1		Akumulatora nodalījums	Šeit ievieto datora akumulatoru.
2		Akumulatora fiksators	Nofiksē akumulatoru.
3		Cietā diska nodalījums	Šeit atrodas datora cietais disks (nostiprināts ar skrūvēm).
4		Atmiņas nodalījums	Šeit atrodas datora pamatatmiņa.
5		Ventilācijas atveres un ventilators	Neļauj datoram sakarst pat pēc ilgstošas lietošanas. <b>Piezīme:</b> Neaizsedziet un nenosprostojiet ventilatora atveri.
6		Akumulatora atbrīvošanas slēdzis	Atbrīvo akumulatoru, lai to varētu izņemt.

## Vide

---

- **Temperatūra:**
    - Ieslēgtā stāvoklī: No 5°C līdz 35°C
    - Izslēgtā stāvoklī: No -20°C līdz 65°C
  - **Mitrums (bez kondensācijas):**
    - Ieslēgtā stāvoklī: No 20% līdz 80%
    - Izslēgtā stāvoklī: No 20% līdz 80%
- 



.....

**Piezīme:** augstākminētās specifikācijas ir tikai piemēri. Precīza jūsu datora konfigurācija ir atkarīga no iegādātā modeļa.

# Aspire 5745/5553 seriju

Trumpa instrukcija

© 2010 Visos teisės saugomos.

Aspire 5745/5553 serijų Trumpa instrukcija  
Pirmasis leidimas: 03/2010

Aspire 5745/5553 serijų nešiojamasis kompiuteris

Modelio numeris: \_\_\_\_\_

Serijos numeris: \_\_\_\_\_

Pirkimo data: \_\_\_\_\_

Pirkimo vieta: \_\_\_\_\_

# Dalykai, kuriuos reikia atlikti pirmiausia

Leiskite padėkoti, kad pasirinkote „Acer“ nešiojamąjį kompiuterį – tikimės Jūsų nenuvilti ir užtikrinti visus nešiojamojo kompiuterio teikiamus privalumus.

## Instrukcijos Jums

Tam, kad palengvintume Jums naudojimąsi „Acer“ kompiuteriu, parengėme kelias instrukcijas:

Pirmoji vadinasi **Pradedantiesiems...** - ši informacija padės pirmosiomis kompiuterio naudojimo minutėmis.

„Aspire“ serijos bendrojoje naudojimo instrukcijoje pateikiama naudinga informacija apie visų Aspire gaminių serijos modelių kompiuterius. Jis apima bendruosius klausimus, kaip, pvz. klaviatūros ir audio sistemos naudojimas ir t.t. Prašome atkreipti dėmesį į tai, jog dėl savo pobūdžio **Bendrojoje naudojimo instrukcijoje** bei **AcerSystem User Guide**, kuris bus minimas toliau, kartais bus aptariamoms funkcijoms ar ypatybėms, būdingoms tik konkrečioms šios serijos modeliams ir nebūtinai tam modeliui, kurį jūs įsigijote. Tokiais atvejais atitinkamose teksto vietose yra priedašais „tik tam tikruose modeliuose“.

**Trumpa instrukcija** pateikiama informacija apie pagrindines Jūsų įsigyto kompiuterio savybes ir funkcijas. Išsamesnės informacijos apie tai, kaip padaryti kompiuterį produktyvesniu, rasite **AcerSystem User Guide**. Šioje instrukcijoje išsamiai aprašoma tokia informacija, kaip sisteminiai failai, duomenų atstatymas, kompiuterio galimybių praplėtimas ir gedimų diagnostika. Be to, šioje instrukcijoje yra ir garantinė informacija, bendrieji reikalavimai ir su sauga susiję įspėjimai. Ši instrukcija yra „Portable Document Format (PDF)“ formate ir ji jau bus kompiuteryje. Jei norite peržiūrėti šią instrukciją:

- 1 Spauskite  **Start (pradėti) > All Programs (visos programos) > AcerSystem.**
- 2 Spauskite **AcerSystem User Guide.**



.....

**Pastaba:** Failo peržiūrai reikės „Adobe Reader“. Jei kompiuteryje nėra „Adobe Reader“, paspaudus ant **AcerSystem User Guide** bus pirmiausiai paleistas „Adobe Reader“ įdiegimas. Vadovaukitės ekrane esančiomis instrukcijomis įdiegimo užbaigimui. Instrukcijų dėl „Adobe Reader“ naudojimosi ieškokite „**Help and Support**“ (**Žinynas ir pagalba**) meniu.

# Ekskursija po jūsų Acer nešiojamąjį kompiuterį

Atlikus kompiuterio sąranką kaip parodyta plakate, leiskite jus supažindinti su jūsų naujuoju Acer nešiojamuoju kompiuteriu.

## Vaizdas iš viršaus

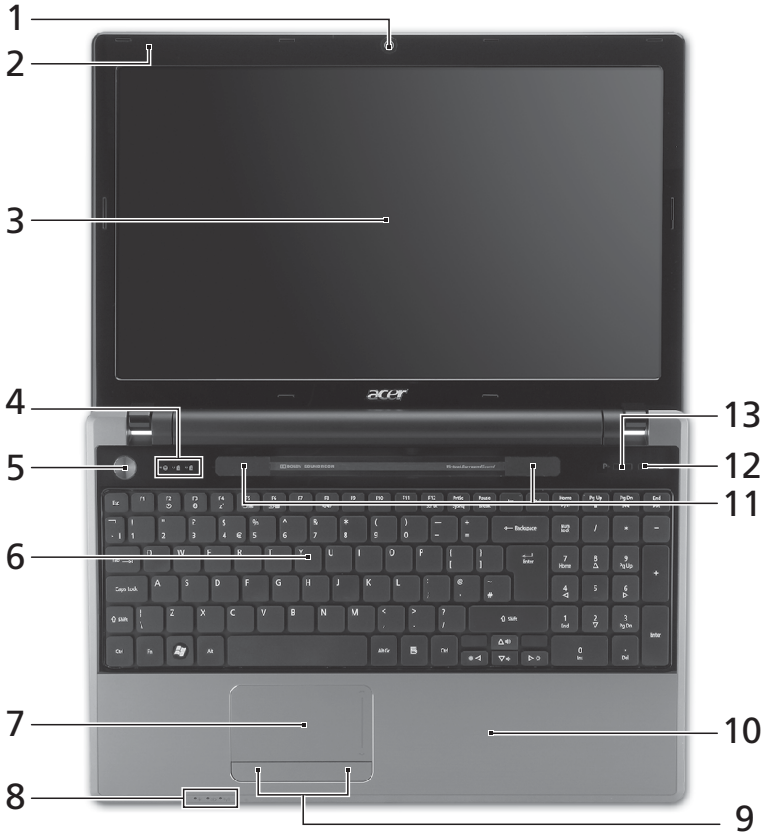

#	Piktograma	Objektas	Aprašymas
1		Acer Crystal Eye interneto kamera	Interneto kamera vaizdinei komunikacijai (tik tam tikruose modeliuose).
2		Mikrofonas	Vidinis mikrofonas garso įrašymui.















#	Piktograma	Objektas	Aprašymas
3		Ekranas	Taip pat vadinamas skystųjų kristalų ekranu (angl. Liquid-Crystal Display (LCD)), jame pateikiamas kompiuterio rodomas vaizdas (konfigūravimo tvarka gali kisti priklausomai nuo modelio).
4		HDD indikatorius	Nurodo ar kietasis diskas yra naudojamas (į jį rašoma ar skaitoma).
		„Num Lock“ indikatorius	Dega kai yra aktyvuotas „Num Lock“ klavišas.
		„Caps Lock“ indikatorius	Dega kai yra aktyvuotas „Caps Lock“ klavišas.
5		Energijos mygtukas	Ijungia ir išjungia kompiuterį.
6		Klaviatūra	Skirta duomenų įvedimui į kompiuterį.
7		Liečiamasis laukelis	Lietimui jautrus įrenginys, veikiantis kaip kompiuterio pelė.
8		Energijos tiekimas <sup>1</sup>	Nurodo kompiuterio energijos sistemos būklę.
		Baterijos indikatorius <sup>1</sup>	Nurodo kompiuterio baterijos būklę. <b>1. Kraunasi:</b> Kraunantis baterijai lemputė dega gintaro spalva. <b>2. Pilnai pakrauta:</b> Dirbant iš kintamos srovės (AC) tinklo lemputė dega mėlynai.
		Komunikacijos indikatorius <sup>1</sup>	Nurodo kompiuterio belaidžio ryšio įtaiso būklę.
9		Pelės klavišai (kairysis ir dešinysis)	Kairysis ir dešinysis klavišai veikia kaip kairysis ir dešinysis pelės mygtukai.
10		Atrama delnui	Patogi atramos vieta jūsų rankoms naudojimosi kompiuteriu metu.
11		Garsiakalbiai	Kairysis ir dešinysis garsiakalbiai transliuoja stereo garsą.
12		Optinių diskų išstūmimo mygtukas	Atidaro optinių diskų įrenginio dureles.
13	<b>P</b>	Programuojamas is klavišas	Programuojamas vartotojo (tik tam tikruose modeliuose).
		„PowerSmart“ klavišas	Ijungia jūsų kompiuterio energijos taupymo režimą (tik tam tikruose modeliuose).

1. Priekinio pulto indikatoriai matomi ne tada, kai kompiuterio viršus yra uždarytas.

## Greitieji klavišai

Kompiuteryje įrengti greitieji klavišai ar numatytos klavišų kombinacijos, leidžiančios valdyti daugelį kompiuterio funkcijų, tokių kaip ekrano ryškumas ar garsiakalbių garsas.

Norėdami pasinaudoti greitaisiais klavišais, prieš spausdami bet kokią greitųjų klavišų kombinaciją nuspauskite ir laikykite klavišus **<Fn>**.

Greitasis klavišas	Piktograma	Funkcija	Aprašymas
<b>&lt;Fn&gt; + &lt;F3&gt;</b>		Komunikacijos mygtukas	Ijungia/išjungia kompiuterio komunikacijos prietaisus (Komunikacijos prietaisai gali skirtis priklausomai nuo konfigūracijos).
<b>&lt;Fn&gt; + &lt;F4&gt;</b>		Sustabdyti	Ijungia hibernacijos (kompiuterio sustabdymo) režimą.
<b>&lt;Fn&gt; + &lt;F5&gt;</b>		Ekranų perjungimas	Perjungia kompiuterio rodomą vaizdą iš kompiuterio monitoriaus į išorinį monitorių (jei prijungtas) ir atvirkščiai.
<b>&lt;Fn&gt; + &lt;F6&gt;</b>		Ekrano išjungimas	Energijos taupymo tikslais išjungia ekraną. Norint vėl įjungti spauskite bet kurį klavišą.
<b>&lt;Fn&gt; + &lt;F7&gt;</b>		Lietimui jautraus ekrano jungiklis	Ijungia ir išjungia lietimui jautrų ekraną.
<b>&lt;Fn&gt; + &lt;F8&gt;</b>		Garsiakalbio jungiklis	Išjungia ir įjungia garsiakalbius.
<b>&lt;Fn&gt; + &lt;▷&gt;</b>		Padidinti ryškumą	Padidina ekrano ryškumą.
<b>&lt;Fn&gt; + &lt;◁&gt;</b>		Sumažinti ryškumą	Sumažina ekrano ryškumą.
<b>&lt;Fn&gt; + &lt;△&gt;</b>		Padidinti garsą	Padidina kompiuterio audio sistemos garsą.
<b>&lt;Fn&gt; + &lt;▽&gt;</b>		Sumažinti garsą	Sumažina kompiuterio audio sistemos garsą.
<b>&lt;Fn&gt; + &lt;Home&gt;</b>		Leisti/ pristabdyti	Leisti ar pristabdyti pasirinktą medijų failą.
<b>&lt;Fn&gt; + &lt;Pg Up&gt;</b>		Stabdyti	Sustabdyti pasirinktą medijų failą.
<b>&lt;Fn&gt; + &lt;Pg Dn&gt;</b>		Ankstesnis	Grįžta prie ankstesnio medijų failo.
<b>&lt;Fn&gt; + &lt;End&gt;</b>		Toliau	Pereina prie paskesnio medijų failo.



## Uždaryto kompiuterio vaizdas iš priekio



#	Piktograma	Objektas	Aprašymas
1		„Multi-in-1“ atminties kortelių skaitytuvas	<p>Skaito Secure Digital (SD), MultiMediaCard (MMC), Memory Stick (MS), Memory Stick PRO (MS PRO), xD-Picture Card (xD) tipų atminties korteles.</p> <p><b>Pastaba:</b> Spauskite norėdami įdėti/išimti kortelę. Vienu metu galima naudotis tik viena kortele.</p>







## Vaizdas iš dešinės

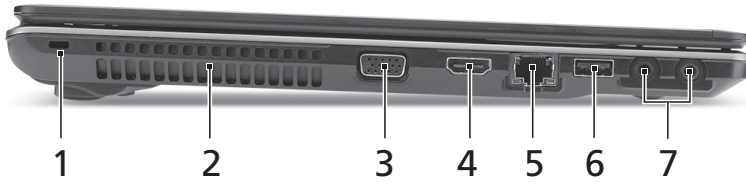

#	Piktograma	Objektas	Aprašymas
1		USB 2.0 lizdas	Skirtas USB 2.0 įrenginiams (pvz., USB pelę, USB kamera) prijungti.
2		Optinių diskų įrenginys	Vidinis optinių diskų įrenginys; skaito CD arba DVD.
3		Optinio disko darbo indikatorius	Dega kai optinių diskų įrenginys dirba.
4		Avarinio atidarymo anga	Atidaro optinių diskų įrenginio dureles kai kompiuteris yra išjungtas. <b>Pastaba:</b> Norėdami esant išjungtam kompiuteriui atidaryti optinių diskų įrenginio dureles, į avarinio atidarymo angą įkiškite sąvarželę.
5		Nuolatinės srovės (DC) kištuko lizdas	Skirtas prijungti kintamos srovės (AC) adapteriui.





## Vaizdas iš kairės

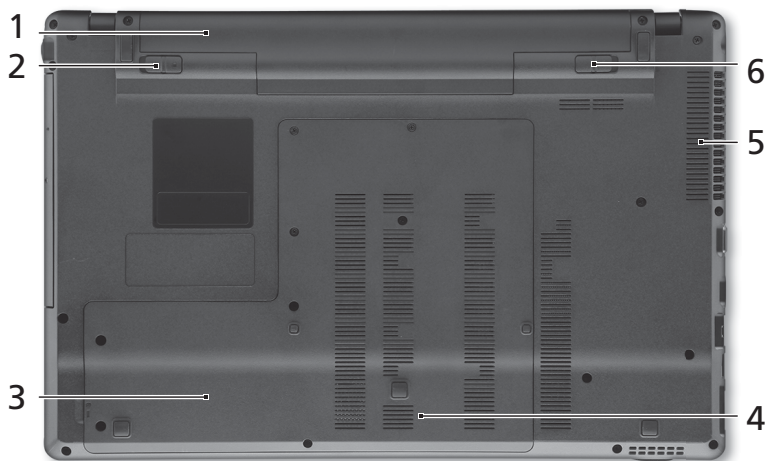

#	Piktograma	Objektas	Aprašymas
1		Kensington spynos lizdas	Skirtas užfiksuoti Kensington tipo kompiuterio užraktui.
2		Ventiliacijos angos	Neleidžia kompiuteriui perkaisti net ir po ilgo naudojimo.
3		Išorinio ekrano (VGA) lizdas	Skirtas prijungti papildomą monitorių (pvz. išorinį monitorių, LCD projektorių).
4		HDMI lizdas	Skirtas pajungti didelės raiškos skaitmeniniams vaizdo prietaisams.
5		Ethernet (RJ-45) lizdas	Skirtas prisijungti prie Ethernet 10/100/1000 tipo tinklo.
6		USB 2.0 lizdas	Skirtas USB 2.0 įrenginiams (pvz., USB pelę, USB kamerą) prijungti.
7		Mikrofono prijungimo lizdas	Skirtas prijungti išorinį mikrofoną.
		Ausinių/ garsiakalbio/ linijinio išėjimo kištukas, palaikantis S/PDIF	Skirtas išoriniams linijiniams audio prietaisams (pvz. garsiakalbiams, ausinėms) prijungti.

## Vaizdas iš apačios



#	Piktograma	Objektas	Aprašymas
1		Baterijos lizdas	Skirtas montuoti kompiuterio baterijai.
2		Baterijos užraktas	Fiksuoja įdėtą bateriją darbinėje padėtyje.
3		Kietųjų diskų lizdas	Montuojamas kietasis diskas (įtvirtintas varžtais).
4		Operatyviosios atminties lizdas	Montuojama pagrindinė kompiuterio atmintis.
5		Ventiliacijos angos ir aušintuvas	Neleidžia kompiuteriui perkaisti net ir po ilgo naudojimo. <b>Pastaba:</b> Neuždenkite ir neužblokuokite ventiliatoriaus ertmės.
6		Baterijos fiksatorius	Atpalaiduoja baterijos fiksavimą, leidžia ją išimti.

## Aplinka

---

- Temperatūra:
    - Darbinė: nuo 5°C iki 35°C
    - Saugojimo: nuo -20°C iki 65°C
  - Drėgmė (be kondensacijos):
    - Darbinė: nuo 20% iki 80%
    - Saugojimo: nuo 20% iki 80%
- 



.....

**Pastaba:** Aukščiau pateikiamos specifikacijos yra tik informacinio pobūdžio. Tiksli jūsų kompiuterio konfigūracija priklauso nuo įsigyto modelio.

Σειρά *Aspire* 5745/5553

Γρήγορος οδηγός

© 2010 Με την επιφύλαξη κάθε νόμιμου δικαιώματος.

Γρήγορος οδηγός σειράς Aspire 5745/5553  
Αρχική Έκδοση: 03/2010

Φορητό PC σειράς Aspire 5745/5553

Αριθμός Μοντέλου: \_\_\_\_\_

Σειριακός Αριθμός: \_\_\_\_\_

Ημερομηνία Αγοράς: \_\_\_\_\_

Τόπος Αγοράς: \_\_\_\_\_

# Όλα με τη σειρά τους

Θα επιθυμούσαμε να σας ευχαριστήσουμε που επιλέξατε το φορητό υπολογιστή της Acer με σκοπό την αντιμετώπιση των αναγκών σας για φορητό υπολογιστή.

## Οι οδηγοί σας

Για να σας βοηθήσουμε στη χρήση του φορητού υπολογιστή της Acer, έχουμε σχεδιάσει ένα σετ εγχειριδίων χρήσης:

Πρώτα απ' όλα, η αφίσα **Μόνο για αρχάριους...** σας βοηθάει να ξεκινήσετε τη ρύθμιση του υπολογιστή σας.

Το έντυπο **Γενικός Οδηγός Χρήσης Σειράς Aspire** περιέχει χρήσιμες πληροφορίες που ισχύουν για όλα τα μοντέλα της σειράς προϊόντων Aspire. Καλύπτει βασικά θέματα, όπως χρήση πληκτρολογίου, Ήχος κ.λ.π. Παρακαλούμε σημειώστε ότι λόγω της φύσης του, ο **Γενικός Οδηγός Χρήσης** καθώς και ο **AcerSystem User Guide** που αναγράφεται πιο κάτω, αναφέρονται περιστασιακά σε λειτουργίες ή δυνατότητες που αφορούν ορισμένα μόνο μοντέλα της σειράς, αλλά όχι αναγκαία το μοντέλο που προμηθευτήκατε. Αυτές οι περιπτώσεις σημειώνονται στο κείμενο με τη φράση "ορισμένα μοντέλα μόνο".

Ο **Γρήγορος οδηγός** παρουσιάζει τις βασικές δυνατότητες και λειτουργίες του νέου σας υπολογιστή. Για περισσότερες πληροφορίες όσον αφορά τον τρόπο με τον οποίο ο υπολογιστής μπορεί να σας βοηθήσει να αυξήσετε την παραγωγικότητά σας, ανατρέξτε στον **AcerSystem User Guide**. Ο οδηγός αυτός περιλαμβάνει λεπτομερείς πληροφορίες σχετικά με θέματα όπως τα βοηθητικά προγράμματα του συστήματος, την επαναφορά δεδομένων, τις επιλογές επέκτασης και την αντιμετώπιση προβλημάτων. Επιπλέον, περιλαμβάνει πληροφορίες σχετικά με την εγγύηση καλής λειτουργίας και τους γενικούς κανονισμούς όπως και τις προειδοποιήσεις ασφάλειας για το φορητό υπολογιστή. Διατίθεται σε μορφή Portable Document Format (PDF) και έχει προ-εγκατασταθεί στον υπολογιστή σας. Ακολουθήστε τα επόμενα βήματα για την πρόσβαση σε αυτόν.

1 Κάντε κλικ στο κουμπί  **Έναρξη > Όλα τα προγράμματα > AcerSystem**.

2 Κάντε κλικ στην επιλογή **AcerSystem User Guide**.



.....

**Σημείωση:** Για να δείτε το αρχείο πρέπει να είναι εγκαταστημένο το πρόγραμμα Adobe Acrobat Reader. Αν δεν είναι εγκατεστημένο το Adobe Acrobat Reader στον υπολογιστή σας, η επιλογή του **AcerSystem User Guide** θα εκτελέσει πρώτα το πρόγραμμα εγκατάστασης του Acrobat Reader. Ακολουθήστε τις οδηγίες στην οθόνη για να ολοκληρώσετε την εγκατάσταση. Για οδηγίες σχετικά με το πώς να χρησιμοποιήσετε το πρόγραμμα Adobe Acrobat Reader, προσπελάστε το μενού **Βοήθεια και Υποστήριξη**.

# Μια ξενάγηση του φορητού υπολογιστή Acer





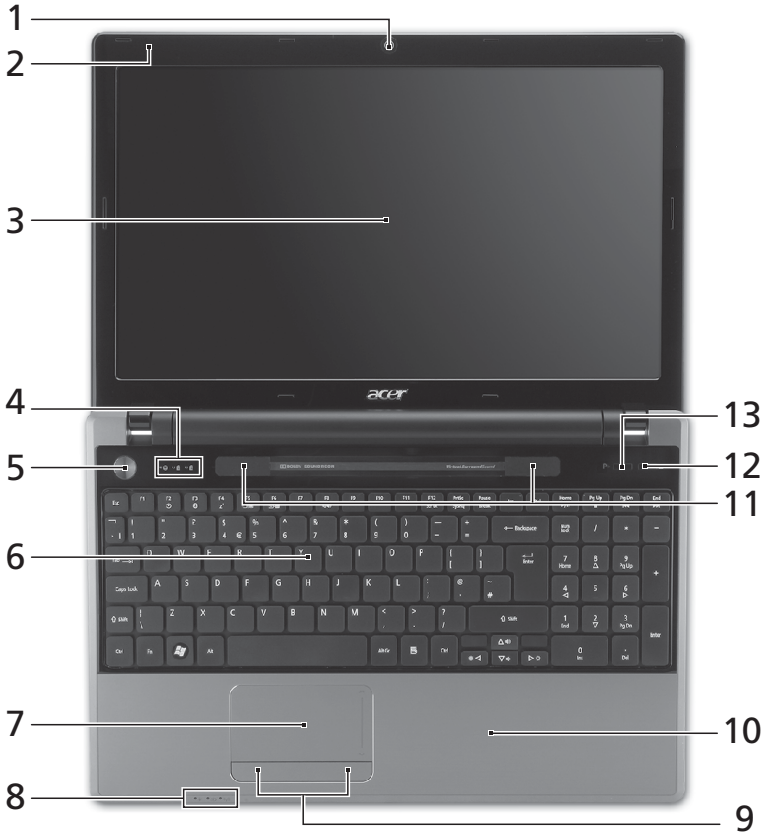



Μετά από την εγκατάσταση του υπολογιστή όπως απεικονίζεται στην αφίσα, θα σας περιγράψουμε τα διάφορα μέρη του νέου σας φορητού υπολογιστή της Acer.

## Κάτοψη



#	Εικονίδιο	Στοιχείο	Περιγραφή
1		Κάμερα διαδικτύου Acer Crystal Eye	Κάμερα διαδικτύου για επικοινωνία βίντεο (ορισμένα μοντέλα μόνο).



#	Εικονίδιο	Στοιχείο	Περιγραφή
2		Μικρόφωνο	Εσωτερικό μικρόφωνο για στερεοφωνικές εγγραφές.
3		Οθόνη απεικόνισης	Αποκαλούμενη επίσης Οθόνη Υγρών Κρυστάλλων (Liquid-Crystal Display; LCD), απεικονίζει την έξοδο του υπολογιστή (Η σύνθεση ενδέχεται να ποικίλλει ανάλογα με το μοντέλο).
4		Ενδεικτική λυχνία HDD	Δηλώνει πότε είναι ενεργοποιημένη η μονάδα του σκληρού δίσκου.
		Ενδεικτική λυχνία Num Lock	Ανάβει όταν ενεργοποιηθεί το Num Lock.
		Ενδεικτική λυχνία Caps Lock	Ανάβει όταν ενεργοποιηθεί το Caps Lock.
5		Κουμπί τροφοδοσίας	Ενεργοποιεί και απενεργοποιεί τον υπολογιστή.
6		Πληκτρολόγιο	Χρησιμοποιείται για την καταχώρηση δεδομένων στον υπολογιστή.
7		Ταμπλέτα αφής	Συσκευή κατάδειξης ευαίσθητη στην αφή που λειτουργεί ως ποντίκι υπολογιστή.
8		Ενδείκτης τροφοδοσίας <sup>1</sup>	Δηλώνει την κατάσταση τροφοδοσίας του υπολογιστή.
		Ενδείκτης μπαταρίας <sup>1</sup>	Δηλώνει την κατάσταση της μπαταρίας του υπολογιστή. <b>1. Φόρτιση:</b> Η ενδεικτική λυχνία κατά τη φόρτιση της μπαταρίας μετατρέπεται σε πορτοκαλί. <b>2. Πλήρως φορτισμένη:</b> Η ενδεικτική λυχνία μετατρέπεται σε μπλε όταν βρίσκεται σε λειτουργία εναλλασσόμενου ρεύματος (AC).
		Ενδεικτική λυχνία επικοινωνίας <sup>1</sup>	Υποδεικνύει την κατάσταση της συσκευής ασύρματης σύνδεσης του υπολογιστή.
9		Κουμπιά κλικ (αριστερό και δεξιό)	Το κουμπί, αριστερό και δεξιό, λειτουργούν σαν τα κουμπιά, αριστερό και δεξιό, του ποντικιού.
10		Στήριγμα παλάμης	Άνετος χώρος στήριξης των χεριών κατά τη χρήση του υπολογιστή.
11		Ηχεία	Τα ηχεία αριστερά και δεξιά παρέχουν στερεοφωνικό ήχο.
12		Κουμπί εκτίναξης της μονάδας οπτικού δίσκου	Χρησιμοποιείται για την εκτίναξη του συρταριού της μονάδας οπτικού δίσκου από τη μονάδα.







#	Εικονίδιο	Στοιχείο	Περιγραφή
13	<b>P</b>	Προγραμματιζόμεν ο πλήκτρο	Προγραμματίζεται από τον χρήστη (ορισμένα μοντέλα μόνο).
		Πλήκτρο PowerSmart	Θέτει τον υπολογιστή σας σε λειτουργία εξοικονόμησης ενέργειας (ορισμένα μοντέλα μόνο).







1. Οι ενδεικτικές λυχνίες της πρόσωσης είναι ορατές ακόμη και όταν το καπάκι του υπολογιστή είναι τελείως κλειστό.

## Πλήκτρα συντόμευσης

Ο υπολογιστής χρησιμοποιεί πλήκτρα συντόμευσης ή συνδυασμούς πλήκτρων για πρόσβαση στα περισσότερα από τα στοιχεία ελέγχου του υπολογιστή όπως η φωτεινότητα οθόνης και η ένταση ήχου.

Για να ενεργοποιήσετε τα πλήκτρα συντόμευσης, πιάστε παρατεταμένα το πλήκτρο **<Fn>** πριν πιάσετε το άλλο πλήκτρο του συνδυασμού πλήκτρων συντόμευσης.

Πλήκτρο συντόμευσης	Εικονίδιο	Λειτουργία	Περιγραφή
<b>&lt;Fn&gt; + &lt;F3&gt;</b>		Πλήκτρο επικοινωνίας	Ενεργοποιεί/απενεργοποιεί τις συσκευές επικοινωνίας του υπολογιστή (Οι συσκευές επικοινωνίας ενδέχεται να διαφέρουν ανάλογα με τη σύνθεση).
<b>&lt;Fn&gt; + &lt;F4&gt;</b>	<b>Z<sup>Z</sup></b>	Αναμονή	Θέτει τον υπολογιστή σε λειτουργία αναμονής.
<b>&lt;Fn&gt; + &lt;F5&gt;</b>		Εναλλαγή οθόνης	Μεταγωγή της εξόδου οθόνης μεταξύ οθόνης απεικόνισης, εξωτερικού μόνιτορ (εάν υπάρχει) ή και των δύο.
<b>&lt;Fn&gt; + &lt;F6&gt;</b>		Οθόνη απενεργοποιημένη	Απενεργοποιεί τον οπίσθιο φωτισμό της οθόνης απεικόνισης για εξοικονόμηση ενέργειας. Πιάστε οποιοδήποτε πλήκτρο για επιστροφή.
<b>&lt;Fn&gt; + &lt;F7&gt;</b>		Εναλλαγή επιφάνειας αφής	Ενεργοποιεί και απενεργοποιεί την εσωτερική επιφάνεια αφής.
<b>&lt;Fn&gt; + &lt;F8&gt;</b>		Εναλλαγή ηχείων	Ενεργοποιεί και απενεργοποιεί τα ηχεία.
<b>&lt;Fn&gt; + &lt;D&gt;</b>		Αύξηση φωτεινότητας	Αυξάνει τη φωτεινότητα της οθόνης.

Πλήκτρο συντόμευσης	Εικονίδιο	Λειτουργία	Περιγραφή
<Fn> + <◀>		Μείωση φωτεινότητας	Μειώνει τη φωτεινότητα της οθόνης.
<Fn> + <▶>		Αύξηση έντασης	Αυξάνει την ένταση του ήχου.
<Fn> + <◃>		Μείωση έντασης	Μειώνει την ένταση του ήχου.
<Fn> + <Αρχική>		Αναπαραγωγή/ Παύση	Αναπαραγωγή ή παύση ενός επιλεγμένου αρχείου μέσων.
<Fn> + <Pg Up>		Διακοπή	Διακοπή αναπαραγωγής του επιλεγμένου αρχείου μέσων.
<Fn> + <Pg Dn>		Προηγούμενο	Επιστροφή στο προηγούμενο αρχείο μέσων.
<Fn> + <End>		Επόμενο	Πηδήξτε στο επόμενο αρχείο μέσων.



## Πρόσοψη με το καπάκι κλειστό



#	Εικονίδιο	Στοιχείο	Περιγραφή
1		Αναγνώστης καρτών πολλών-σε-1	Δέχεται Secure Digital (SD), MultiMediaCard (MMC), Memory Stick (MS), Memory Stick PRO (MS PRO), και xD-Picture Card (xD). <b>Σημείωση:</b> Πιέστε για αφαίρεση/τοποθέτηση της κάρτας. Δυνατότητα λειτουργίας μόνο μιας κάρτας κάθε φορά.

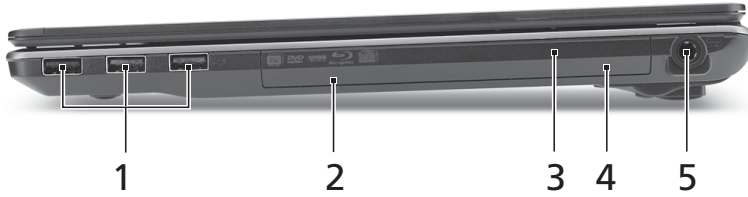





## Δεξιά πλευρά

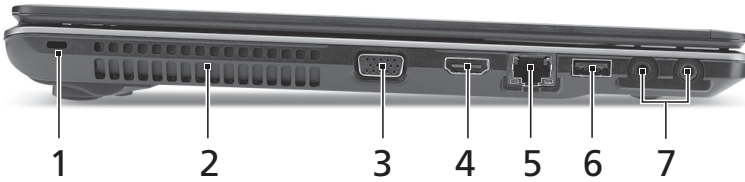

#	Εικονίδιο	Στοιχείο	Περιγραφή
1		Θύρα USB 2.0	Συνδέεται σε συσκευές USB 2.0 (π.χ. ποντίκι USB, κάμερα USB).
2		Μονάδα οπτικού δίσκου	Εσωτερική μονάδα οπτικού δίσκου, δέχεται CD ή DVD.
3		Φωτεινή ένδειξη πρόσβασης οπτικού δίσκου	Ανάβει κατά την ενεργοποίηση της μονάδας οπτικού δίσκου.
4		Οπή έκτακτης εκτίναξης	Χρησιμοποιείται για την εκτίναξη του συρταριού της μονάδας οπτικού δίσκου όταν ο υπολογιστής είναι απενεργοποιημένος. <b>Σημείωση:</b> Τοποθετήστε ένα μεταλλικό συνδετήρα μέσα στην οπή έκτακτης εκτίναξης για εκτίναξη του συρταριού της μονάδας οπτικού δίσκου όταν ο υπολογιστής είναι απενεργοποιημένος.
5		Τζακ εισόδου συνεχούς ρεύματος (DC)	Συνδέεται σε προσαρμογέα εναλλασσόμενου ρεύματος (AC).





## Αριστερή πλευρά

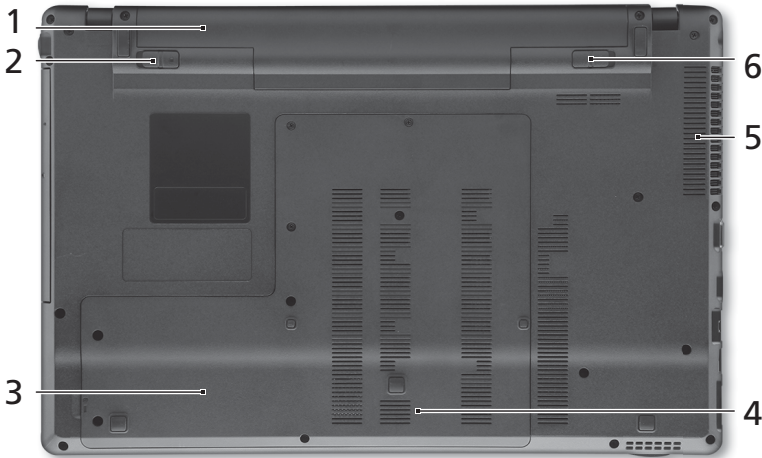

#	Εικονίδιο	Στοιχείο	Περιγραφή
1		Υποδοχή λουκέτου τύπου Kensington	Συνδέεται σε λουκέτο ασφαλείας υπολογιστή συμβατό με Kensington.
2		Θυρίδες εξαερισμού	Διατηρούν τον υπολογιστή σε χαμηλή θερμοκρασία, ακόμη και ύστερα από παρατεταμένη χρήση.
3		Θύρα εξωτερικής οθόνης απεικόνισης (VGA)	Συνδέεται σε συσκευή απεικόνισης (π.χ. εξωτερικό μόνιτορ, προβολέα LCD).
4		Θύρα HDMI	Υποστηρίζει συνδέσεις ψηφιακού βίντεο υψηλής ανάλυσης.
5		Θύρα Ethernet (RJ-45)	Συνδέεται σε δίκτυο Ethernet 10/100/1000.
6		Θύρα USB 2.0	Συνδέεται σε συσκευές USB 2.0 (π.χ. ποντίκι USB, κάμερα USB).
7		Τζακ μικροφώνου	Δέχεται εισόδους από εξωτερικά μικρόφωνα.
		Τζακ ακουστικών/ηχείων/γραμμής εξόδου με υποστήριξη S/PDIF	Συνδέεται σε συσκευές με γραμμή εξόδου ακουστικού σήματος (π.χ. ηχεία, ακουστικά).

## Άποψη βάσεως



#	Εικονίδιο	Στοιχείο	Περιγραφή
1		Φατνίο μπαταρίας	Περιέχει το πακέτο μπαταρίας του υπολογιστή.
2		Λουκέτο μπαταρίας	Ασφαλίζει τη μπαταρία στη θέση της.
3		Φατνίο σκληρού δίσκου	Περιέχει το σκληρό δίσκο του υπολογιστή (ασφαλίζεται με βίδες).
4		Διαμέρισμα μνήμης	Περιέχει την κύρια μνήμη του υπολογιστή.
5		Θυρίδες εξαερισμού και ανεμιστήρας ψύξης	Διατηρούν τον υπολογιστή σε χαμηλή θερμοκρασία, ακόμη και ύστερα από παρατεταμένη χρήση. <b>Σημείωση:</b> Μην καλύπτετε ή παρεμποδίζετε το άνοιγμα του ανεμιστήρα.
6		Μάνδαλο απασφάλισης μπαταρίας	Απασφαλίζει τη μπαταρία για αφαίρεση.

## Περιβάλλον

---

- Θερμοκρασία:
    - Λειτουργίας: 5°C έως 35°C
    - Μη λειτουργίας: -20°C έως 65°C
  - Υγρασία (μη συμπυκνούμενη):
    - Λειτουργίας: 20% έως 80%
    - Μη λειτουργίας: 20% έως 80%
- 



.....

**Σημείωση:** Οι ανωτέρω προδιαγραφές παρατίθενται για λόγους παραπομπής μόνο. Η ακριβής σύνθεση του PC εξαρτάται από το μοντέλο που αγοράσατε.





# Aspire 5745/5553 Serisi

Hızlı Başlama Kılavuzu

© 2010 Tüm Hakları Saklıdır.

Aspire 5745/5553 Serisi Hızlı Başlama Kılavuzu  
Orijinal İhraç: 03/2010

Aspire 5745/5553 Serisi Dizüstü Bilgisayarı

Model numarası: \_\_\_\_\_

Seri numarası: \_\_\_\_\_

Satın alma tarihi: \_\_\_\_\_

Satın alma yeri: \_\_\_\_\_

# İlk şeyler ilk

Mobil bilgisayar ihtiyaçlarınızı karşılamak için tercihinizi Acer dizüstü bilgisayardan yana yaptığınız için teşekkür ederiz.

## Rehberleriniz

Acer dizüstü bilgisayarı kullanırken size yardımcı olması için bir dizi rehber tasarladık:

İlk önce, **Sadece Başlayanlar için...** poster bilgisayarınızı başlatmanıza yardım eder.

Bazılı **Aspire Serisi Gelen Kılavuzu** Aspire ürün serisindeki tüm modellere uygulanan faydalı bilgiler içermektedir. Klavyeyi kullanma, Ses vs. gibi temel konular içermektedir. Lütfen aşağıda bahsedilen **Acer Sistem Kullanıcı Kılavuzu**'nun yanı sıra **Genel Kılavuz**'un doğası gereği zaman zaman serinin sadece belirli modellerinde bulunan işlev ve özelliklere başvurduğunu ancak satın aldığınız modelde gerekli olmayabileceğini unutmayın. Bu durumda metin "sadece belirli modeller" yazısıyla işaretlenmiştir.

Yazılı **Hızlı Başlama Kılavuzu** size bilgisayarınızın temel özelliklerini ve işlevlerini tanıtır. Daha verimli olmak için bilgisayarınızın size nasıl yardım ettiğini görmek için lütfen **AcerSistem Kullanıcı Kılavuzu**'na bakın. Bu rehber; sistem işlevleri, veri kurtarma, genişletme seçenekleri ve sorun giderme gibi konular üzerine detaylı bilgi içerir. Ayrıca; garanti bilgisi ve dizüstü bilgisayarınız için genel kurallar ve güvenlik önlemleri içerir. PDF dosyası içinde mevcuttur ve dizüstü bilgisayarınızda önceden yüklüdür. Ona ulaşmak için bu adımları takip edin:

- 1  **Başlat > Tüm Programlar'a > AcerSistemi**'ni tıklayın.
- 2 **AcerSistemi Kullanıcı Kılavuzu**'nu tıklayın.



-----

**Not:** Adobe Reader gerektiren dosyayı inceleme. Adobe Reader bilgisayarınızda yüklü değilse **AcerSistemi Kullanıcı Kılavuzu**'nu tıklamak Adobe Reader ayarlama programını çalıştıracaktır. Bu yüklemeyi tamamlamak için ekrandaki yönergeleri takip edin. Adobe Reader'ın nasıl kullanıldığını öğrenmek için, **Yardım ve Destek** menüsüne girin.

# Acer dizüstü bilgisayarınızda bir gezinti

Bilgisayarınızı posterde gösterildiği gibi ayarladıktan sonra yeni Acer dizüstü bilgisayarınızı tanıtmamıza izin verin.

## Üstten görünüş

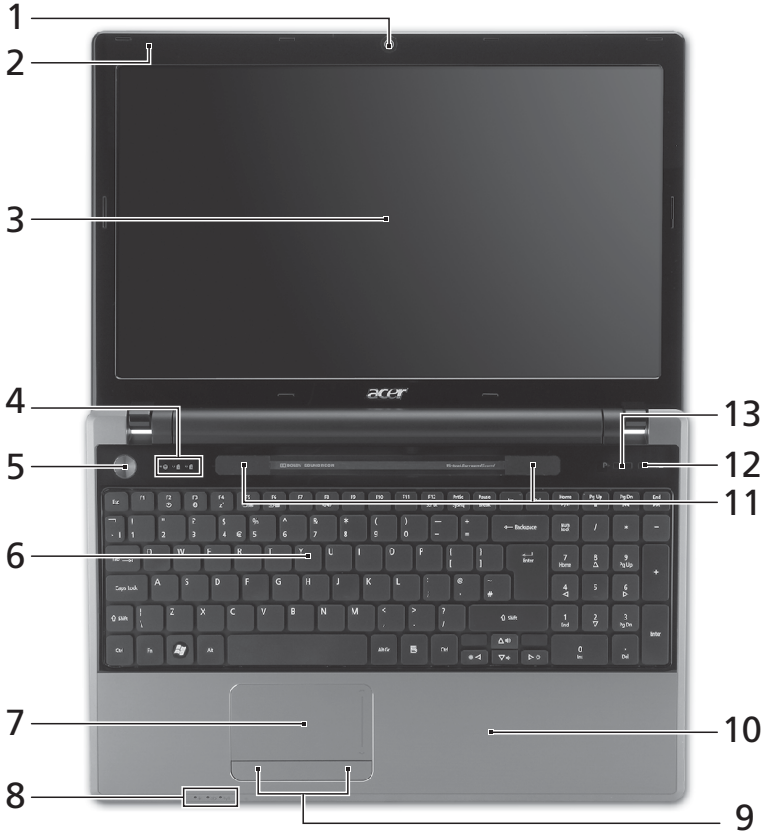

#	Simge Öğe	Tanım
1	Acer Crystal Eye video kamera	Video iletişimi için Web kamerası (sadece belirli modeller).













#	Simge	Öge	Tanım
2		Mikrofon	Ses kaydı için dahili mikrofon.
3		Görüntü ekranı	Sıvı Kristalli Görüntü (LCD) olarak da bilinir ve bilgisayar çıktılarını gösterir (yapılandırma modellere göre farklı olabilir).
4		HDD göstergesi	Sabit diskin etkin olduğunu gösterir.
		Num Lock göstergesi	Num Lock etkin olduğunda yanar.
		Caps Lock göstergesi	Caps Lock etkin olduğunda yanar.
5		Açma/kapama düğmesi	Bilgisayarı açar ve kapatır.
6		Klavye	Bilgisayarınıza veri girebilmek için.
7		Dokunmatik yüzey	Bilgisayar faresi gibi fonksiyonu olan, dokunmaya duyarlı işaret aygıtı.
8		Güç göstergesi <sup>1</sup>	Bilgisayarın güç durumunu gösterir.
		Batarya göstergesi <sup>1</sup>	Bilgisayarın pil durumunu gösterir. <b>1. Şarj:</b> Pil şarj olurken ışık kehribar renginde yanar. <b>2. Tamamen şarj oldu:</b> AC modundayken ışık mavi yanar.
		İletişim göstergesi <sup>1</sup>	Bilgisayarın kablosuz bağlantı durumunu gösterir.
9		Tuşlar (sol ve sağ)	Sol ve sağ tuşlar, bilgisayar faresinin sağ ve sol tuşları ile aynı fonksiyondadır.
10		Palmrest	Bilgisayarı kullanırken ellerinizi destekleyen rahat bir alan.
11		Hoparlörler	Sol ve sağ hoparlörler stereo ses çıkışı verir.
12		Optik sürücü çıkarma tuşu	Optik diski sürücüden çıkarır.
13		Programlanabilir tuşlar	Kullanıcı tarafından programlanabilir (sadece belirli modeller).
		PowerSmart tuşu	Bilgisayarınızı güç tasarrufu moduna çevirir (sadece belirli modeller).

1. Ön panel göstergeleri bilgisayar kapağı kapalı olsa bile görülebilir.

## Kısayol Tuşları

Bilgisayarda, ekran parlaklığı ve ses çıkışı gibi bilgisayarın birçok kontrolüne erişimin sağlanması için faydalı tuşlar yer almaktadır.

Faydalı tuşları etkinleştirmek için, faydalı tuş kombinasyonundaki diğer tuşa basmadan önce <Fn> tuşuna basılı tutun.

Faydalı tuş	Simge	İşlev	Tanım
<Fn> + <F3>		İletişim anahtarı	Bilgisayarın iletişim aygıtlarını etkinleştirir/engeller (İletişim aygıtları yapılandırılmaya göre farklılık gösterebilir).
<Fn> + <F4>		Uyku	Bilgisayarı Uyku moduna sokar.
<Fn> + <F5>		Ekran değişikliği	Görüntü ekranı, harici monitör (eğer bağlıysa) ve ikisi arasında ekran çıkışını değiştirir.
<Fn> + <F6>		Ekran kapalı	Görüntü ekranı arkasını kapatır, güçten kazanmak için kapatır. Geriye dönmek için herhangi bir tuşa basın.
<Fn> + <F7>		Dokunmatik yüzey değişikliği	Dahili dokunmatik yüzeyi açar ve kapatır.
<Fn> + <F8>		Hoparlör değişikliği	Hoparlörleri açar ve kapatır.
<Fn> + <↑>		Parlaklığı artır	Ekran parlaklığını artırır.
<Fn> + <↓>		Parlaklığı azalt	Ekran parlaklığını azaltır.
<Fn> + <△>		Ses aç	Sesi artırır.
<Fn> + <▽>		Ses kapat	Sesi azaltır.
<Fn> + <Giriş>		Yürüt/Duraklat	Seçilen ortam dosyasını oynatın veya duraklatın.
<Fn> + <Pg Up>		Durdur	Seçilen ortam dosyasının oynatılmasını durdurur.
<Fn> + <Pg Dn>		Önceki	Önceki ortam dosyasına döner.
<Fn> + <Bitir>		İleri	Sonraki ortam dosyasına geçer.



## Kapalı ön görünüm



#	Simge	Öge	Tanım
1		Çoklu kart okuyucu	Güvenli Dijital (SD), Çoklu Ortam Kartı (MMC), Bellek Çubuğu (MS), Bellek Çubuğu PRO (MS PRO), xD-Görüntü Kartı (xD)'ni kabul eder. <b>Not:</b> Kartı çıkartmak/takmak için itin. Her hangi bir zamanda sadece bir kart çalışabilir.

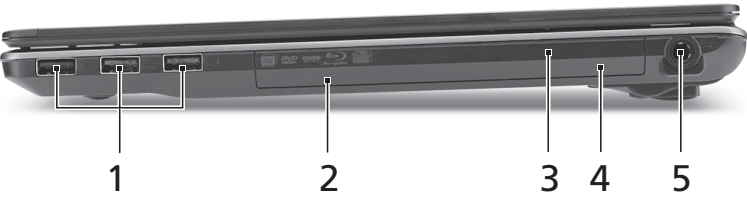





## Sağ görünüm

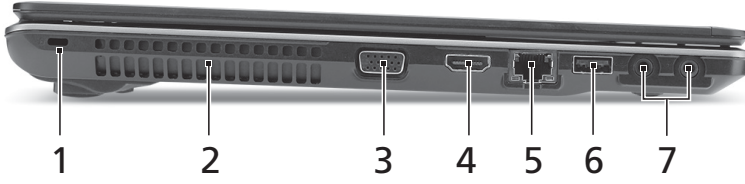

#	Simge	Öge	Tanım
1		USB 2.0 portu	USB 2.0 cihazlarına bağlantıyı sağlar (örneğin USB fare, USB kamera).
2		Optik sürücü	Dahili optik sürücü; CD'leri veya DVD'leri kabul eder.
3		Optik sürücü erişim göstergesi	Optik sürücü etkinken yanar.
4		Acil durum çıkarma yuvası	Bilgisayara kapandığında optik sürücü yatağını çıkarır. <b>Not:</b> Bilgisayar kapatıldığında optik sürücü tepsisini çıkarmak için acil durum çıkarma yuvasına bir kağıt atacı takın.
5		DC-in jakı	AC adaptöre bağlanır.

## Sol görünüm







#	Simge	Öge	Tanım
1		Kensington kilit yuvası	Kensington-uyumlu bilgisayar güvenliğine bağlar.
2		Havalandırma yuvaları	Bilgisayarınızın uzun kullanımlar sonrası bile ısınmamasını sağlarlar.
3		Harici görüntü (VGA) portu	Bir görüntü aygıtına bağlar (örneğin, harici monitör, LCD projektör).
4		HDMI portu	Yüksek çözünürlüklü dijital video bağlantılarını destekler.
5		Ethernet (RJ-45) portu	Ethernet 10/100/1000-temelli ağa bağlar.
6		USB 2.0 portu	USB 2.0 cihazlarına bağlantıyı sağlar (örneğin USB fare, USB kamera).
7		Mikrofon jakı	Harici mikrofon girişlerini kabul eder.
		S/PDIF desteği ile kulaklıklar/hoparlör/hat çıkışı jakı	Sesli line-out cihazlarına bağlantıyı sağlar (örneğin hoparlör, kulaklık).

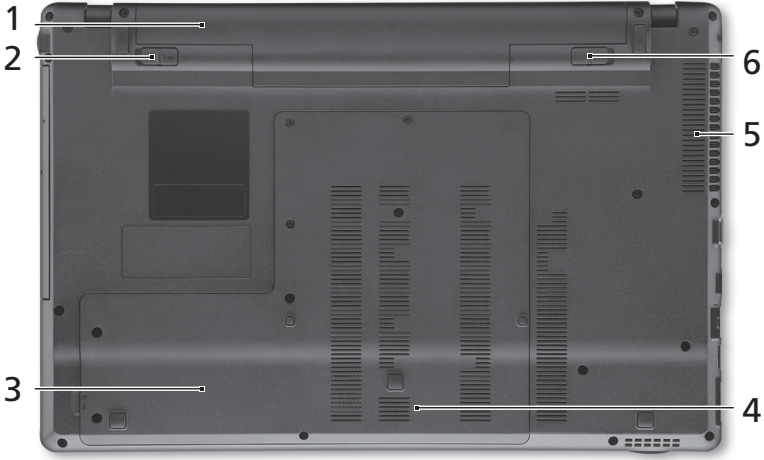

## Alt görünüm



#	Simge	Öge	Tanım
1		Pil bölmesi	Bilgisayar pil takımının yeridir.
2		Pil kilidi	Pil yerine oturduğunda kilitlet.
3		Sabit disk bölmesi	Bilgisayarın sabit diskini barındırır (vidalarla sabitlenmiştir).
4		Bellek bölmesi	Bilgisayarın ana hafızasını barındırır.
5		Havalandırma delikleri ve soğutma fanı	Bilgisayarınızın uzun kullanımlar sonrası bile ısınmamasını sağlarlar. <b>Not:</b> Fanın girişini tıkamayın.
6		Pil çıkarma mandalı	Eskiyen pilleri çıkarmanız içindir.

## Ortam

---

- Sıcaklık:
    - Çalışma: 5°C ila 35°C arasında
    - Çalışmadığı durumda: -20°C ila 65°C arasında
  - Nem (yoğunlaşmayan):
    - Çalışma: %20 ila %80 arasında
    - Çalışmadığı durumda: %20 ila %80 arasında
- 



.....

**Not:** Yukarıda listelenen spesifikasyonlar sadece referans içindir. Bilgisayarınızın gerçek konfigürasyonu satın aldığınız modele bağlıdır.

# Aspire 5745/5553 シリーズ

クイックガイド

© 2010 All Rights Reserved.

Aspire 5745/5553 シリーズブックガイド  
初版：2010年3月

Aspire 5745/5553 シリーズノートブックコンピューター

モデル番号： \_\_\_\_\_

シリアル番号： \_\_\_\_\_

購入日： \_\_\_\_\_

購入場所： \_\_\_\_\_

# はじめに

この度は、Acer ノートブック PC をお買い上げいただき、誠にありがとうございます。  
ます。

## ガイド

本製品を快適にご使用いただくために、次のガイドが提供されています。

**Aspire シリーズユーザーガイド**には、Aspire シリーズの全モデルに共通の情報が記載されています。本書にはキーボード、オーディオの使い方など、基本的な情報が含まれています。**ユーザーガイド**および以下に紹介する **AcerSystem User Guide** (ユーザーガイド)に記載される説明の中には、特定モデルにのみ適用されるものがあり、お客様が購入されたモデルには該当しない場合があります。そのような場合には、「特定モデルのみ」などのように注記が付けられています。

**クイックガイド**は、本 PC を生産的に使用するための方法を説明します。

**AcerSystem User Guide** (ユーザーガイド) は、本 PC についてわかりやすく説明しておりますので、良くお読み頂き、指示に従ってください。このガイドには、システムユーティリティ、データ復元、拡張オプション、トラブルシューティングなどの詳細情報を記載しております。また、このノート PC の保証、一般規制、安全規定についても記載しています。マニュアルを印刷する必要がある場合、ユーザーズマニュアルは PDF (Portable Document Format) ファイルで提供されています。以下の手順に従ってください。

1.  **スタート > すべてのプログラム > Acer System** をクリックしてください。
2. **AcerSystem User Guide** (ユーザーガイド) をクリックしてください。





.....





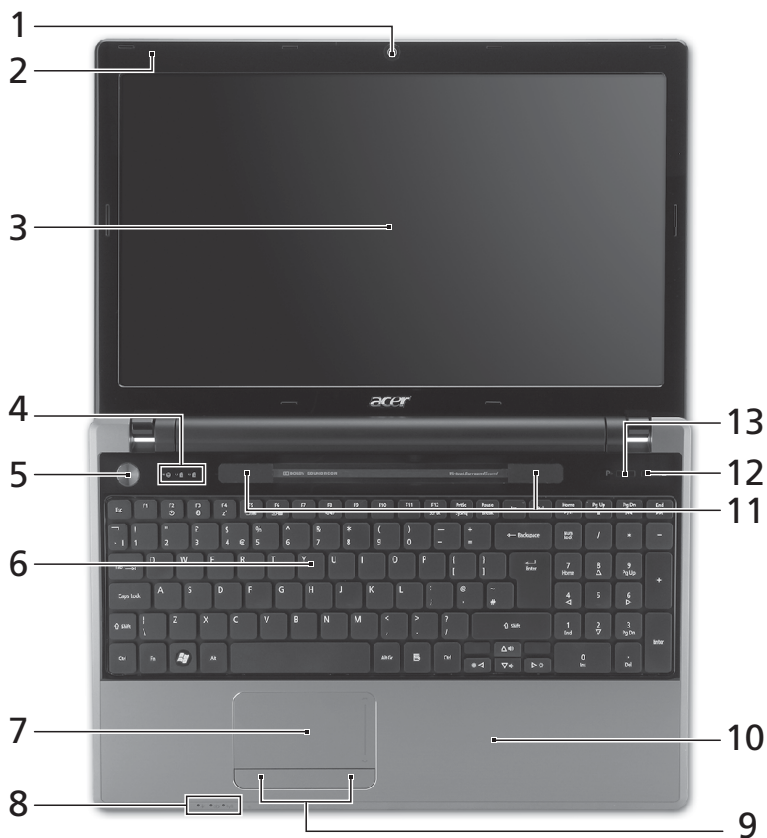



**注意:** ファイルを表示するには、Adobe Reader が必要となります。  
AdobeReader の使い方については、「**Adobe Reader ヘルプ**」にアクセスしてください。

## Acer ノートブックツアー

## 上面



#	アイコン	アイテム	説明
1		Acer Crystal Eye ウェブカメラ	ビデオコミュニケーション用のウェブカメラです(特定モデルのみ)。
2		マイク	録音用の内部マイクです。
3		ディスプレイスクリーン	液晶ディスプレイ (LCD) とも呼びます。コンピュータ出力を表示します(構成はモデルによって異なります)。

#	アイコン	アイテム	説明
4		HDD インジケータ	ハードディスクドライブがアクティブになると点灯します。
		Num Lock インジケータ	Num Lock 機能を使っているときに点灯します。
		Caps Lock インジケータ	Caps Lock 機能を使っているときに点灯します。
5		電源ボタン	コンピュータの電源をオン/オフにします。
6		キーボード	コンピュータにデータを入力します。
7		タッチパッド	コンピュータマウスと同じように機能し、指を触れることで反応するポインティングデバイスです。
8		電源インジケータ <sup>1</sup>	PCの電源がオンのときに点灯します。
		バッテリーインジケータ <sup>1</sup>	バッテリーパックが充電されているときに点灯します。 <b>1. 充電中</b> ：バッテリーを充電している間、ランプは琥珀色に点灯します。 <b>2. 完全に充電</b> ：ACモードでは、ライトが青くなります。
		通信インジケータ <sup>1</sup>	PCワイヤレス接続装置がオンのときに点灯します。
9		クリックボタン (左、右)	左右のボタンはマウスの左右のボタンと同じように機能します。
10		パームレスト	コンピュータ操作時に手を置く場所です。
11		スピーカー	左右スピーカーから、ステレオオーディオが出力されます。
12		光学ドライブ ジェクトボタン	ドライブから光学ディスクを取り出します。
13		プログラム可能な キー	ユーザー設定が可能です (特定モデルのみ)。
		PowerSmart キー	コンピュータを省電力モードにします (特定モデルのみ)。

1. フロントパネルのインジケータは、コンピュータカバーが閉じた状態でも見えるようになっています。

## ホットキー

このコンピュータでは、ホットキーや2つ以上のキーを組み合わせることで、画面の輝度や出力音量など、コンピュータのほとんどのコントロールを調整することができます。

ホットキーを利用するときは、<Fn> キーを押しながら、ホットキーの組み合わせとなる、もう1つのキーを押してください。

ホットキー	アイコン	機能	説明
<Fn> + <F3>		通信キー	コンピュータの通信機器を有効 / 無効にします (通信機器は、構成内容によって異なります)。
<Fn> + <F4>		スリープ	PC をスリープモードに切り替えます。
<Fn> + <F5>		ディスプレイ切り替え	ディスプレイ出力を、ディスプレイスクリーン、外付けモニター (接続されている場合)、またはその両方に切り替えます。
<Fn> + <F6>		ディスプレイオフ	ディスプレイのバックライトをオフにして、電源を節約します。キーをどれか押すと、バックライトはオンになります。
<Fn> + <F7>		タッチパッド ON / OFF	内蔵タッチパッドをオン / オフにします。
<Fn> + <F8>		スピーカー ON / OFF	スピーカーをオン / オフにします。
<Fn> + <↑>		輝度を上げる	画面輝度が上がります。
<Fn> + <↓>		輝度を下げる	画面輝度が下がります。
<Fn> + <△>		ボリュームアップ	スピーカーのボリュームを上げます。
<Fn> + <▽>		ボリュームダウン	スピーカーのボリュームを下げます。
<Fn> + <Home>		再生 / 一時停止	選択したメディアファイルを再生または一時停止します。
<Fn> + <Pg Up>		中止	選択したメディアファイルの再生を中止します。
<Fn> + <Pg Dn>		戻る	前のメディアファイルに戻ります。
<Fn> + <End>		次へ	次のメディアファイルに移動します。



## 前面 (閉じたとき)



#	アイコン	アイテム	説明
1		1 台多機能のカードリーダー	Secure Digital (SD)、MultiMediaCard (MMC)、Memory Stick (MS)、Memory Stick PRO (MS PRO)、xD-Picture Card (xD) に対応しています。 <b>注意：</b> 押すと、カードの取り出し / 挿入ができます。一度に 1 枚のカードしか操作できません。







## 右面

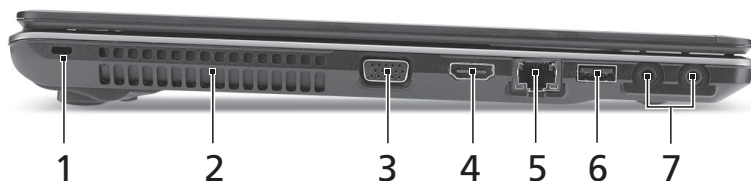

#	アイコン	アイテム	説明
1		USB 2.0 ポート	USB 2.0 デバイスを接続します (USB マウス、USB カメラなど)。
2		光学ドライブ	内部光学ドライブ (CD および DVD に対応)。
3		光学ディスクアクセスインジケータ	光学ドライブが使用中のときには点灯します。
4		緊急用イジェクトホール	コンピュータがオフになっているときに、光学ドライブトレイを引き出します。 <b>注意：</b> コンピュータがオフの状態の場合は、緊急用イジェクトホールにペーパークリップを差し込むと光学ドライブトレイが出てきます。
5		DC 入力ジャック	AC アダプタに接続します。





## 左面

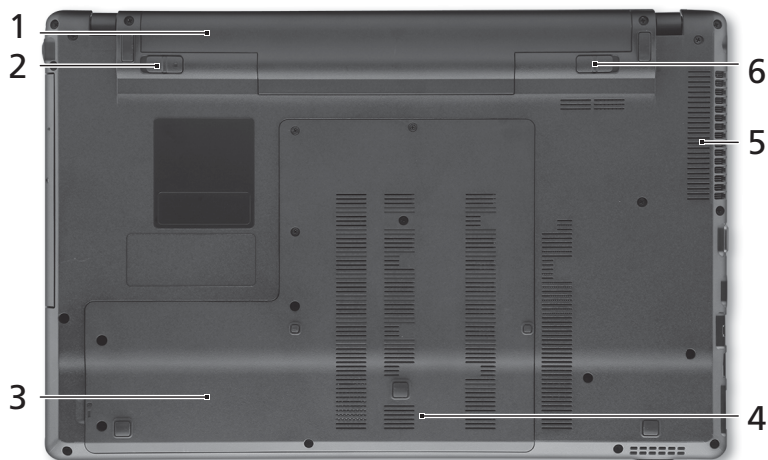

#	アイコン	アイテム	説明
1		Kensington ロック スロット	Kensington 対応コンピュータセキュリティロックに接続します。
2		通気孔	長時間使用してもコンピュータが過熱しないよう冷却します。
3		外部ディスプレイ (VGA) ポート	ディスプレイデバイスに接続します (外付けモニター、LCD プロジェクタなど)。
4		HDMI ポート	高性能デジタルビデオ接続対応します。
5		Ethernet (RJ-45) ポート	Ethernet 10/100/1000 ベースのネットワークに接続します。
6		USB 2.0 ポート	USB 2.0 デバイスを接続します (USB マウス、USB カメラなど)。
7		マイクロフォン ジャック	外部マイクロフォンを接続します。
		ヘッドフォン / スピーカー / SPDIF 対応出力 ジャック	オーディオ出力デバイスを接続します (スピーカー、ヘッドフォンなど)。

## 底面



#	アイコン	アイテム	説明
1		バッテリーベイ	コンピュータのバッテリーパックを装着します。
2		バッテリーロック	バッテリーを定位置にロックします。
3		ハードディスクベイ	コンピュータのハードディスクを装着します(ネジで固定)。
4		メモリコンパートメント	コンピュータのメインメモリを装着します。
5		通気孔スロットと冷却ファン	長時間使用してもコンピュータが過熱しないよう冷却します。 <b>注意:</b> ファンの通気穴を塞いだり、異物を詰め込んだりしないでください。
6		バッテリー取り外しつまみ	バッテリーを取り出します。

## 環境

---

- 温度：
    - 操作時：5°C ~ 35°C
    - 非操作時：-20°C ~ 65°C
  - 湿度（結露しないこと）：
    - 操作時：20% ~ 80%
    - 非操作時：20% ~ 80%
- 



.....

**注意：**上記の仕様は参照用です。PCの正確な構成は、お客様が購入されたモデルにより異なります。

# Aspire 5745/5553 시리즈

빠른 시작 설명서

© 2010 All Rights Reserved.

Aspire 5745/5553 시리즈 빠른 시작 설명서  
최초 발행일 : 03/2010

Aspire 5745/5553 시리즈 노트북 PC

모델 번호 : \_\_\_\_\_

일련 번호 : \_\_\_\_\_

구입 날짜 : \_\_\_\_\_

구입 장소 : \_\_\_\_\_

# 사용 전 유의 사항

Acer 노트북을 선택해주셔서 감사합니다. 이 노트북이 귀하의 모바일 컴퓨팅 요구를 충족시켜 드릴 것입니다.

## 제공되는 설명서

Acer 노트북을 사용하는 데 도움을 줄 수 있는 여러 설명서가 제공됩니다:

우선 **사용을 위한 준비** 포스터는 컴퓨터 설정을 시작하는 데 유용합니다.

**Aspire 시리즈 일반 사용 설명서**에는 Aspire 제품 시리즈의 모든 모델에 적용되는 유용한 정보가 포함되어 있습니다. 이 설명서에서는 키보드 사용, 오디오 등과 같은 기본적인 주제를 다룹니다. 설명서의 특성상, 아래 언급된 **AcerSystem 사용 설명서 및 일반 사용 설명서**에는 이 시리즈의 특정 모델에만 있고 귀하가 구입한 모델에는 없는 기능 또는 특징에 대한 설명이 포함되어 있을 수 있음을 양지하십시오. 그러한 부분에는 "특정 모델에만 해당"과 같은 텍스트가 표시되어 있습니다.

**빠른 시작 설명서**에서는 새 컴퓨터의 기본 특징 및 기능을 소개합니다. 컴퓨터를 좀 더 생산적으로 활용하는 방법에 대한 자세한 내용은 **AcerSystem 사용 설명서**를 참조하십시오. 이 설명서에서는 시스템 유틸리티, 데이터 복구, 확장 옵션 및 문제 해결과 같은 주제를 자세하게 설명합니다. 또한 노트북에 대한 일반 규정과 안전 주의 사항 및 보증 정보가 포함되어 있습니다. 이 설명서는 PDF (Portable Document Format) 파일로 제공되며 노트북에 이미 설치되어 있습니다. 이 설명서에 액세스하려면 다음 단계를 수행하십시오.

- 1  **Start (시작) > All Programs (모든 프로그램) > AcerSystem** 을 클릭합니다.
- 2 **AcerSystem 사용 설명서**를 클릭합니다.



.....

**참고:** 이 파일을 보려면 Adobe Reader 가 필요합니다. 컴퓨터에 Adobe Reader 가 설치되어 있지 않은 경우 **AcerSystem 사용 설명서**를 클릭하면 자동으로 Adobe Reader 설치 프로그램이 실행됩니다. 화면의 지시에 따라 나머지 설치 과정을 완료합니다. Adobe Reader 사용 방법에 대한 지침을 보려면 **Help and Support** (도움말 및 지원) 메뉴에 액세스하십시오.

# Acer 노트북 둘러보기





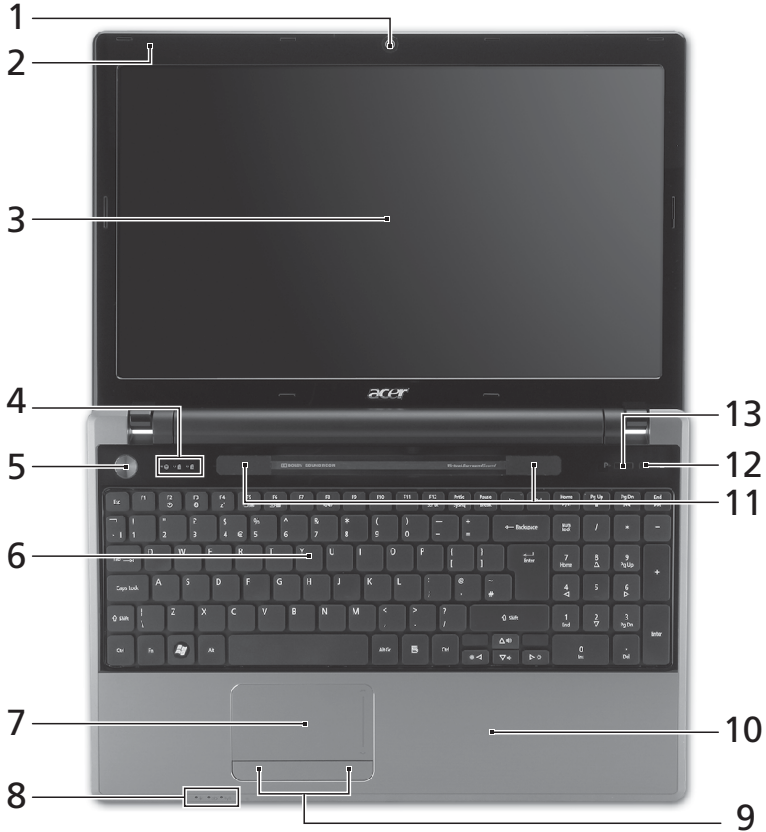



포스터에 설명된 대로 컴퓨터를 설정했다면 이제 새 Acer 노트북을 살펴볼 차례입니다.

## 위에서 본 모습



#	아이콘	항목	설명
1		Acer Crystal Eye 웹캠	비디오 통신용 웹 카메라입니다 (특정 모델에만 해당).
2		마이크	소리를 녹음할 수 있는 내부 마이크입니다.



#	아이콘	항목	설명
3		디스플레이 화면	LCD ( 액정 디스플레이 ) 라고도 하며 , 컴퓨터 출력을 표시합니다 ( 구성은 모델에 따라 다를 수 있습니다 ).
4		HDD 표시등	하드 디스크 드라이브가 동작 중이면 불이 켜집니다 .
		Num Lock 표시등	Num Lock 이 활성화되어 있으면 불이 켜집니다 .
		Caps Lock 표시등	Caps Lock 이 활성화되어 있으면 불이 켜집니다 .
5		전원 단추	컴퓨터를 켜고 끕니다 .
6		키보드	컴퓨터에 데이터를 입력하는 데 사용됩니다 .
7		터치패드	컴퓨터 마우스와 같은 역할을 하는 접촉식 포인팅 장치입니다 .
8		전원 표시등 <sup>1</sup>	컴퓨터의 전원 상태를 표시합니다 .
		배터리 표시등 <sup>1</sup>	컴퓨터의 배터리 상태를 표시합니다 . <b>1. 충전 중 :</b> 배터리가 충전 중이면 황색 불이 켜집니다 . <b>2. 충전 완료 :</b> AC 모드일 때 파란 불이 켜집니다 .
		통신 표시등 <sup>1</sup>	컴퓨터의 무선 연결 장치 상태를 표시합니다 .
9		누름 단추들 ( 왼쪽 및 오른쪽 )	왼쪽과 오른쪽의 단추는 마우스의 왼쪽 및 오른쪽 단추와 같은 역할을 합니다 .
10		손목 받침대	컴퓨터를 사용할 때 편안하게 손을 올려 놓는 영역입니다 .
11		스피커	왼쪽 스피커와 오른쪽 스피커로 스테레오 오디오를 출력합니다 .
12		광드라이브 꺼내기 단추	드라이브에서 광디스크를 꺼냅니다 .
13		프로그램 가능 키 PowerSmart 키	사용자가 프로그램 가능 ( 특정 모델에만 해당 ) . 컴퓨터를 절전 모드로 전환합니다 ( 특정 모델에만 해당 ) .

1. 전면 패널 표시등은 컴퓨터 덮개를 닫은 상태에서도 볼 수 있습니다 .

## 바로 가기 키

컴퓨터에서는 화면 밝기와 볼륨 출력 같은 대부분의 컴퓨터 컨트롤에 액세스하기 위해 바로 가기 키 또는 키 조합이 사용됩니다.

바로 가기 키를 활성화하려면 바로 가기 키 조합의 다른 키를 누르기 전에 **<Fn>** 키를 누릅니다.

바로 가기 키	아이콘	기능	설명
<b>&lt;Fn&gt; + &lt;F3&gt;</b>		통신 키	컴퓨터의 통신 장치를 활성화 / 비활성화합니다 (통신 장치는 구성에 따라 다를 수 있습니다).
<b>&lt;Fn&gt; + &lt;F4&gt;</b>		절전	컴퓨터를 절전 모드로 설정합니다.
<b>&lt;Fn&gt; + &lt;F5&gt;</b>		디스플레이 전환	디스플레이 출력을 디스플레이 화면, 외부 모니터 (연결된 경우) 또는 둘 다에 보내도록 선택합니다.
<b>&lt;Fn&gt; + &lt;F6&gt;</b>		디스플레이 끄기	전원을 절약하기 위해 디스플레이 화면의 백라이트를 끕니다. 화면을 다시 켜려면 임의의 키를 누릅니다.
<b>&lt;Fn&gt; + &lt;F7&gt;</b>		터치패드 전환	내부 터치패드를 켜고 끕니다.
<b>&lt;Fn&gt; + &lt;F8&gt;</b>		스피커 전환	스피커를 켜고 끕니다.
<b>&lt;Fn&gt; + &lt;D&gt;</b>		밝게	화면 밝기를 증가시킵니다.
<b>&lt;Fn&gt; + &lt;D&gt;</b>		어둡게	화면 밝기를 감소시킵니다.
<b>&lt;Fn&gt; + &lt;Δ&gt;</b>		볼륨 크게	소리를 높입니다.
<b>&lt;Fn&gt; + &lt;▽&gt;</b>		볼륨 작게	소리를 낮춥니다.
<b>&lt;Fn&gt; + &lt;Home&gt;</b>		재생 / 일시 중지	선택된 미디어 파일을 재생 또는 일시 중지합니다.
<b>&lt;Fn&gt; + &lt;Pg Up&gt;</b>		중지	선택된 미디어 파일 재생을 중지합니다.
<b>&lt;Fn&gt; + &lt;Pg Dn&gt;</b>		이전	이전 미디어 파일로 돌아갑니다.
<b>&lt;Fn&gt; + &lt;End&gt;</b>		다음	다음 미디어 파일로 이동합니다.



## 닫힌 상태의 앞 모습



#	아이콘	항목	설명
1		멀티 카드 판독기	Secure Digital (SD), MultiMediaCard (MMC), Memory Stick (MS), Memory Stick PRO (MS PRO) 및 xD-Picture Card (xD) 를 사용할 수 있습니다. <b>참고 :</b> 카드를 눌러 제거 또는 설치합니다 . 카드를 한 번에 하나만 사용할 수 있습니다 .

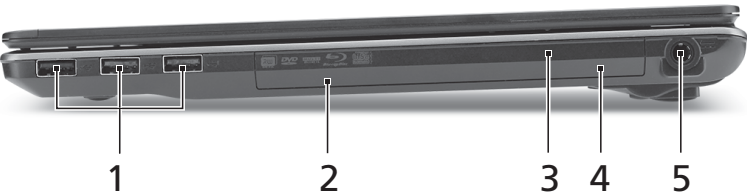





## 오른쪽 모습

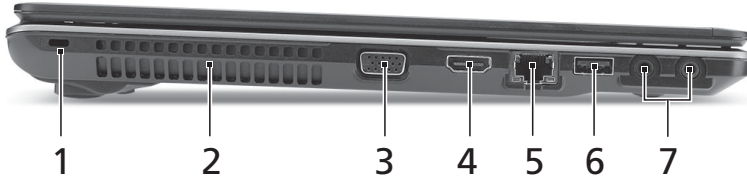

#	아이콘	항목	설명
1		USB 2.0 포트	USB 2.0 장치 ( 예 : USB 마우스 , USB 카메라 ) 에 연결합니다 .
2		광드라이브	내부 광드라이브 . CD 또는 DVD 를 넣습니다 .
3		광디스크 액세스 표시등	광드라이브가 작동 중이면 불이 켜집니다 .
4		비상용 꺼내기 구멍	컴퓨터가 꺼졌을 때 광드라이브 트레이를 꺼낼 수 있습니다 . <b>참고 :</b> 컴퓨터가 꺼졌을 때 클립을 비상용 꺼내기 구멍에 삽입하여 광드라이브 트레이를 꺼내십시오 .
5		DC 입력 잭	AC 어댑터에 연결합니다 .





## 왼쪽 모습

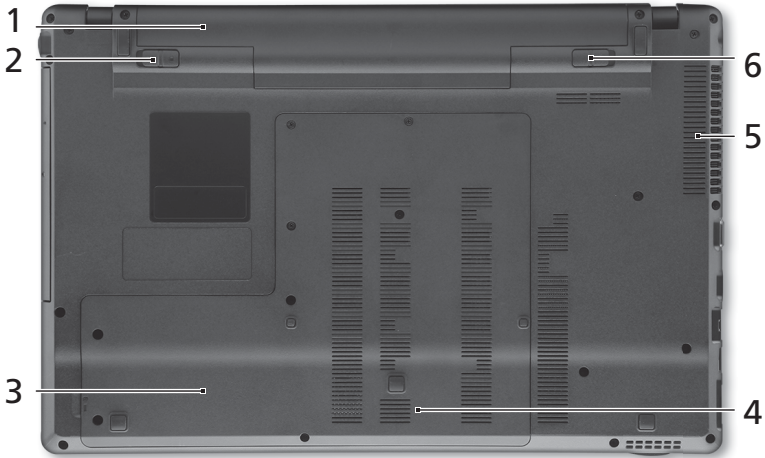

#	아이콘	항목	설명
1		Kensington 잠금 장치 슬롯	Kensington 호환 컴퓨터 보호용 잠금 장치를 연결합니다.
2		통풍용 슬롯	장시간 사용한 후에도 컴퓨터를 차갑게 유지할 수 있습니다.
3		외부 디스플레이 (VGA) 포트	디스플레이 장치 (예 : 외부 모니터 , LCD 프로젝터) 를 연결합니다.
4		HDMI 포트	고선명 디지털 비디오 연결을 지원합니다.
5		이더넷 (RJ-45) 포트	10/100/1000 이더넷 네트워크에 연결합니다.
6		USB 2.0 포트	USB 2.0 장치 ( 예 : USB 마우스 , USB 카메라 ) 에 연결합니다.
7		마이크 잭	외부 마이크로 소리를 입력할 때 사용합니다.
		헤드폰 / 스피커 / 출력 잭 (SPDIF 지원) ( 예 : 스피커 , 헤드폰).	오디오 출력 장치에 연결합니다

## 바닥 모습



#	아이콘	항목	설명
1		배터리 장착부	컴퓨터의 배터리 팩을 넣습니다.
2		배터리 잠금	장착된 배터리를 빠지지 않도록 잠급니다.
3		하드 디스크 장착부	컴퓨터의 하드 디스크를 넣습니다 (나사로 고정).
4		메모리 장착부	컴퓨터의 주 메모리를 넣습니다.
5		통풍용 슬롯 및 냉각 팬	장시간 사용한 후에도 컴퓨터를 차갑게 유지할 수 있습니다. <b>참고:</b> 팬의 입구를 막거나 차단하지 마십시오.
6		배터리 제거용 래치	제거를 위해 배터리를 뺄 때 사용합니다.

## 환경

---

- 온도 :
    - 작동 : 5°C - 35°C
    - 비작동 : -20°C - 65°C
  - 습도 (비응축):
    - 작동 : 20% - 80%
    - 비작동 : 20% - 80%
- 



.....

**참고 :** 위에 나열된 사양은 참고 목적으로만 제공됩니다 . PC 의 정확한 구성 내용은 구입한 모델에 따라 다릅니다 .

# Aspire 5745/5553 系列

快速使用指南

© 2010 版權所有

Aspire 5745/5553 系列快速使用指南  
初版：2010 年 3 月

Aspire 5745/5553 系列筆記型電腦

產品型號： \_\_\_\_\_

產品序號： \_\_\_\_\_

購買日期： \_\_\_\_\_

購買地點： \_\_\_\_\_



# 首要之務

首先，非常感謝您選擇 Acer 筆記型電腦，成為您行動運算生活的最佳夥伴。

## 使用指南

為協助您順利使用 Acer 筆記型電腦，我們特地設計了以下的使用指南：

首先，**入門者專用 ...** 海報可以協助您開始設定您的電腦。

**Aspire 系列一般使用指南**內含有用的資訊，適用於 Aspire 產品系列的所有機型。其中涵蓋基本主題，例如使用鍵盤、音訊等。請注意，由於其性質不同，以下提及的**一般使用指南**和 **AcerSystem User Guide** 可能會參考到只有特定系列機型所含的功能或特點，而您所購買的機型不一定會包含這些功能。這些情況會以如「僅適用於特定機型」的文字加以標註。

本**快速使用指南**介紹了本電腦的基本特性和功能。有關本電腦如何幫助您提高效率的資訊，請參閱 **AcerSystem User Guide**。本手冊包含系統公用程式、資料復原、擴充選項和疑難排解等詳細資訊。此外，本手冊也提供保固資訊和本電腦的一般規格和安全注意事項。另外，本電腦也預先載入了本使用手冊的 PDF (Portable Document Format) 格式檔案。若要開啓此 PDF 檔案，請依下列步驟操作：

- 1 按一下  **開始 > 所有程式 > AcerSystem**。
- 2 按一下 **AcerSystem User Guide**。



.....

**注意：**要閱讀 PDF 檔案時，必須先安裝 Adobe Reader。如果您的系統沒有安裝 Adobe Reader，按一下 **AcerSystem User Guide** 會先執行 Adobe Reader 設定程式。請依畫面指示說明完成安裝。如需使用 Adobe Reader 的指示，請點選 **說明和支援** 功能表以獲得更詳細的使用說明。



# Acer 筆記型電腦導覽

在依照海報中所提及的說明完成電腦的設定之後，就讓我們為您展示一下全新 Acer 筆記型電腦的各項功能吧！

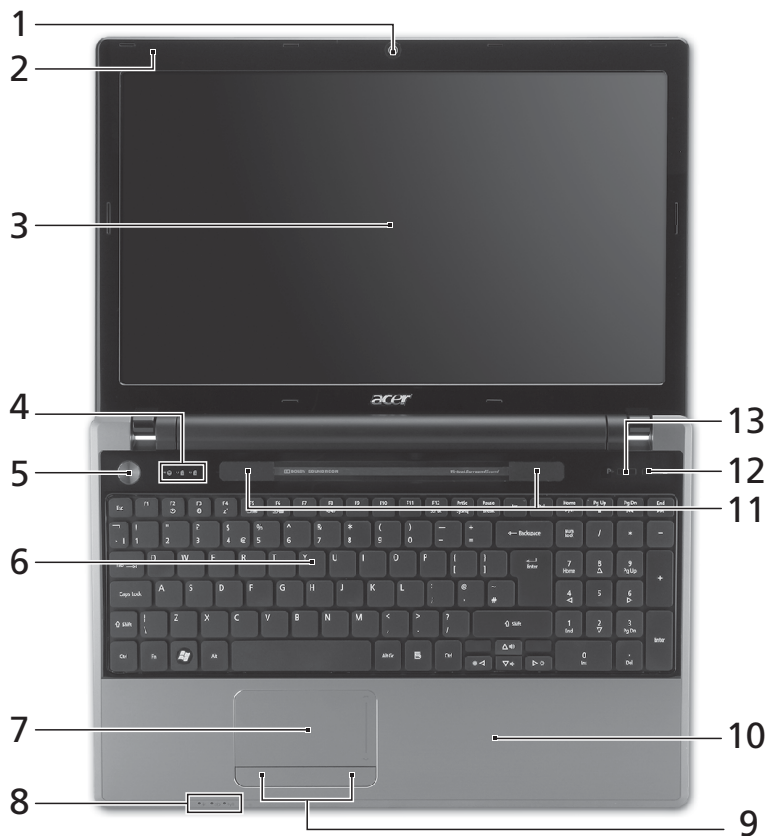
## 上視圖



#	圖示	項目	說明
1		Acer Crystal Eye 網路攝影機	網路相機，可用於視訊通訊（僅適用於特定機型）。
2		麥克風	用於錄音的內建麥克風。

#	圖示	項目	說明
3		顯示螢幕	亦稱為液晶顯示器 (Liquid-Crystal Display ; LCD)，用於顯示電腦資料的輸出 (設定將依機型而有所不同)。
4		硬碟指示燈	當存取硬碟時，指示燈會亮起。
		Num Lock 指示燈	Num Lock 功能啟用時，指示燈會亮起。
		Caps Lock 指示燈	Caps Lock 功能啟用時，指示燈會亮起。
5		電源鍵	開啓和關閉電腦。
6		鍵盤	可用來將資料輸入電腦。
7		觸控板	觸控感應式移動游標裝置，功能等同於電腦的滑鼠。
8		電源指示燈 <sup>1</sup>	表示電腦的電源狀態。
		電池指示燈 <sup>1</sup>	表示電腦的電池狀態。 <b>1. 充電中：</b> 當電池在充電時，指示燈會亮琥珀色。 <b>2. 充電完畢：</b> 當使用 AC 電源模式時，指示燈會亮藍色。
		通訊指示燈 <sup>1</sup>	表示電腦無線連線能力的狀態。
9		點選鍵 (左和右)	左鍵和右鍵的功能等同於滑鼠的左鍵和右鍵。
10		腕靠	讓您在使用電腦時，可舒適擺放手腕的位置。
11		喇叭	左右兩個喇叭提供立體音效的輸出。
12		光碟退出鍵	可將光碟從光碟機中退出。
13		自訂功能鍵	使用者可自訂 (僅適用於特定機型)。
		PowerSmart 鍵	讓電腦進入省電模式 (僅適用於特定機型)。

1. 即使在電腦螢幕關上時，您依然可看見位於前面板的狀態指示燈。

## 快速鍵

利用此電腦的快捷鍵或組合鍵可存取大部分的控制指令，例如：螢幕亮度和音量輸出。

若要使用快速鍵，請先按住 **<Fn>** 鍵，再按下組合鍵的另一按鍵。

快速鍵	圖示	功能	說明
<b>&lt;Fn&gt; + &lt;F3&gt;</b>		通訊鍵	啓用 / 停用電腦的通訊裝置 (通訊裝置可能根據組態而有所不同)。
<b>&lt;Fn&gt; + &lt;F4&gt;</b>		睡眠	讓電腦進入睡眠模式。
<b>&lt;Fn&gt; + &lt;F5&gt;</b>		螢幕顯示切換	在顯示螢幕和外接顯示器 (如有連接) 之間切換輸出，或同時顯示。
<b>&lt;Fn&gt; + &lt;F6&gt;</b>		關閉顯示螢幕	關閉顯示螢幕背光，以節省電力。按下任意鍵即可返回。
<b>&lt;Fn&gt; + &lt;F7&gt;</b>		觸控板切換鈕	開啓和關閉內建的觸控板。
<b>&lt;Fn&gt; + &lt;F8&gt;</b>		喇叭切換鈕	開啓和關閉喇叭。
<b>&lt;Fn&gt; + &lt;▷&gt;</b>		調高亮度	調高螢幕亮度。
<b>&lt;Fn&gt; + &lt;◁&gt;</b>		調低亮度	調低螢幕亮度。
<b>&lt;Fn&gt; + &lt;△&gt;</b>		提高音量	提高喇叭音量。
<b>&lt;Fn&gt; + &lt;▽&gt;</b>		降低音量	降低喇叭音量。
<b>&lt;Fn&gt; + &lt;Home&gt;</b>		播放 / 暫停	播放或暫停選取的媒體檔。
<b>&lt;Fn&gt; + &lt;Pg Up&gt;</b>		停止	停止播放選取的媒體檔。
<b>&lt;Fn&gt; + &lt;Pg Dn&gt;</b>		上一個	返回上一個媒體檔。
<b>&lt;Fn&gt; + &lt;End&gt;</b>		下一個	跳到下一個媒體檔。

## 上蓋闔起的前視圖



#	圖示	項目	說明
1		多合一讀卡機	可支援 Secure Digital (SD)、MultiMediaCard (MMC)、Memory Stick (MS)、Memory Stick PRO (MS PRO)、xD-Picture Card (xD)。 <b>注意：</b> 輕壓即可移除 / 安裝卡片。無論何時皆只能使用一張卡片。







## 右視圖

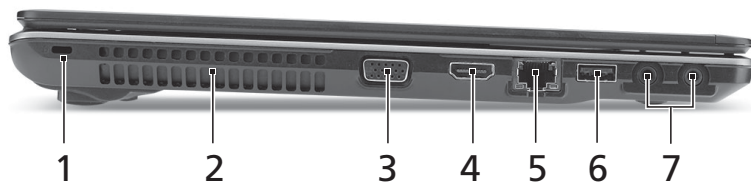

#	圖示	項目	說明
1		USB 2.0 埠	連接到 USB 2.0 裝置 (例如：USB 滑鼠、USB 網路攝影機)。
2		光碟機	內部光碟機，可放入 CD 或 DVD。
3		光碟存取指示燈	當正在存取光碟時，指示燈會亮起。
4		緊急退出孔	可在電腦關機狀態下退出光碟機托盤。 <b>注意：</b> 在電腦關機時將迴紋針插入緊急退出孔，即可退出光碟機托盤。
5		DC 輸入插孔	連接到 AC 變壓器。





## 左視圖

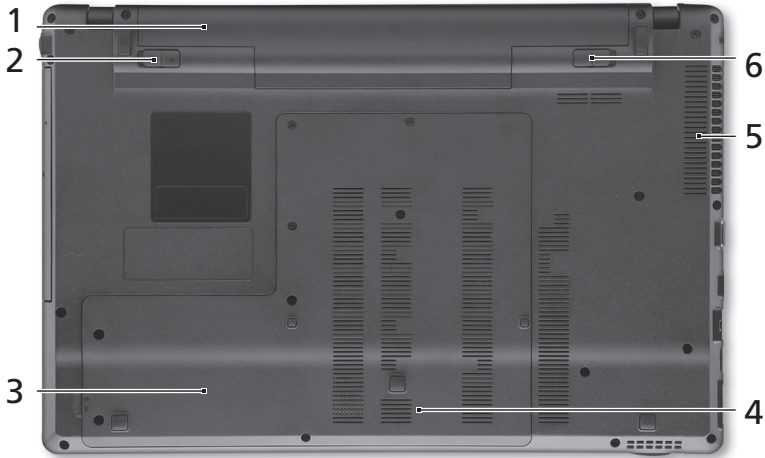

#	圖示	項目	說明
1		Kensington 安全鎖插槽	連接到與 Kensington 相容的電腦安全鎖。
2		通風槽	可讓電腦在長時間使用後仍然能夠保持冷卻狀態。
3		外接顯示螢幕 (VGA) 連接埠	連接顯示器裝置 (例如：外接螢幕、LCD 投影機)。
4		HDMI 埠	支援高清晰度數位視訊連線。
5		乙太網路 (RJ-45) 連接埠	連接到以 10/100/1000 為基礎的乙太網路。
6		USB 2.0 埠	連接到 USB 2.0 裝置 (例如：USB 滑鼠、USB 網路攝影機)。
7		麥克風插孔	接受從外接麥克風所輸入的聲音。
		耳機 / 喇叭 / 音訊輸出插孔 (支援 S/PDIF)	連接外接音訊輸出裝置的插孔 (例如：喇叭、耳機)。

## 底視圖



#	圖示	項目	說明
1		電池槽	用於安裝電腦的電池組。
2		電池組固定鎖	可將電池鎖到定位。
3		硬碟槽	用於安裝電腦的硬碟 (以螺絲固定)。
4		記憶體槽	用於安裝電腦的主記憶體。
5		散熱孔和冷卻風扇	可讓電腦在長時間使用後仍然能夠保持冷卻狀態。 <b>注意：</b> 請勿阻塞或擋住風扇開口。
6		電池卸除卡榫	用於卸下電池組。

## 環境

---

- 溫度：
    - 操作中：5°C 到 35°C
    - 非操作中：-20°C 到 65°C
  - 溼度 (非冷凝狀態)：
    - 操作中：20% 到 80%
    - 非操作中：20% 到 80%
- 



注意：上述規格僅供參考。實際 PC 的規格會視購買的機型而定。



# Aspire 5745/5553 系列

快速指南

© 2010 保留所有权利

Aspire 5745/5553 系列快速指南  
初版发行日期：2010 年 3 月

Aspire 5745/5553 系列笔记本电脑

产品型号： \_\_\_\_\_

产品序号： \_\_\_\_\_

购买日期： \_\_\_\_\_

购买地点： \_\_\_\_\_

# 使用入门

感谢您选购 Acer 笔记本电脑，让它成为您行动运算生活的最得力助手。

## 用户指南

为帮助您设置和使用 Acer 笔记本电脑，我们为您设计了以下用户指南：

首先请按照电脑所附带的**入门指南 ... 彩图**来安装电脑。

**Aspire 系列普通用户指南**包含了关于 Aspire 产品系列所有型号的有用信息。该手册包括键盘和音频的使用方法等基本内容。请注意，鉴于手册的性质，**普通用户指南**和下文中提到的 **AcerSystem User Guide** 偶尔也会提及本系列产品中部分型号专有的功能或特性，但您购买的型号不一定具有这些功能或特性。以上情况会以“仅限部分型号”等字样在文中注明。

这份**快速指南**向您介绍新电脑的基本特性和功能。要了解您的电脑如何能够帮助您更加具有效益详情，请参见 **AcerSystem User Guide**。本指南包含了诸如系统实用程序、数据恢复、扩展选项和疑难解答等信息。此外，它还包含了保修信息和笔记本电脑的一般规则和安全注意事项。我们也提供了 PDF 格式的用户指南并已预先安装在本电脑中供用户参考，请按下列步骤操作来查看该 PDF：

- 1 单击  **开始 > 所有程序 > AcerSystem**。
- 2 单击 **AcerSystem User Guide**。



.....

**注：**查看 PDF 文件需要预先安装 Adobe Reader。如果您的电脑没有预先安装 Adobe Reader 单击 **AcerSystem User Guide** 后将会先启动 Adobe Reader 安装程序。依屏幕上指导完成安装程序。要获得如何使用 Adobe Reader 的指导，请使用**帮助和支持**菜单。

# 熟悉 Acer 笔记本电脑

当您按照彩图中的示例安装完电脑后，就让我们一起来熟悉您的 Acer 笔记本电脑吧。

## 俯视图

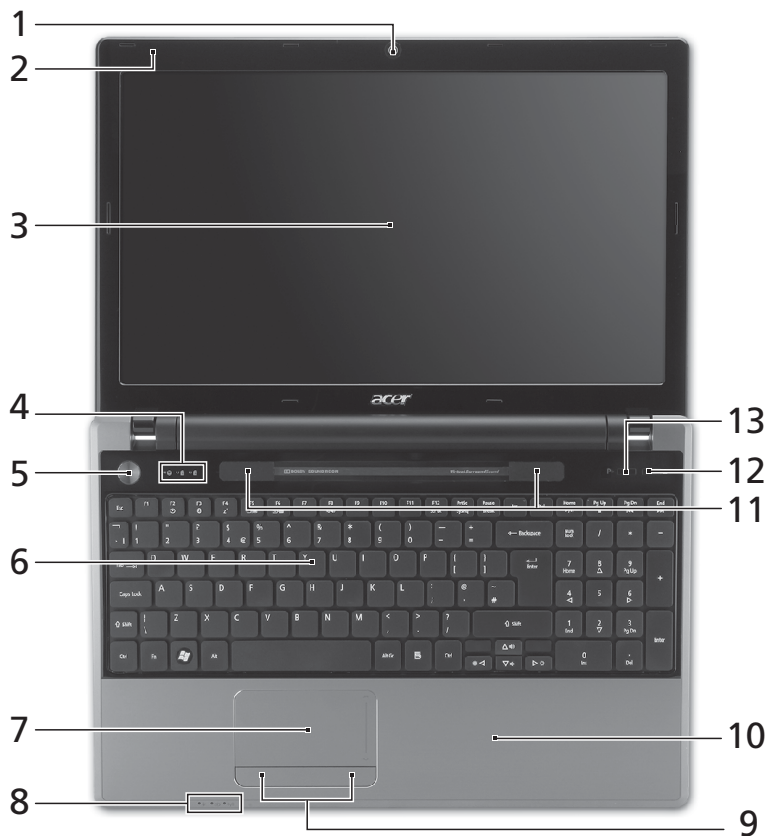

#	图标	项目	描述
1		Acer Crystal Eye 摄像头	网络相机，用于视频通信（仅限部分型号）。
2		麦克风	用于录音的内置麦克风。

#	图标	项目	描述
3		显示屏	也称液晶显示屏 (Liquid-Crystal Display ; LCD), 用于显示电脑的输出内容 (不同型号配置可能有所不同)。
4		硬盘指示灯	硬盘活动时, 该指示灯亮。
		[Num Lock] (数字锁定键) 指示灯	当 Num Lock 键启用时, 该指示灯亮。
		[Caps Lock] (大写锁定) 指示灯	当 Caps Lock 键启用时, 该指示灯亮。
5		电源按钮	用于打开和关闭电脑电源。
6		键盘	将数据输入到电脑中。
7		触控板	触摸式定位设备, 功能和电脑鼠标相同。
8		电源指示灯 <sup>1</sup>	根据亮灯情况可检视目前电脑电源的状态。
		电池指示灯 <sup>1</sup>	根据亮灯情况可检视目前电脑电池的状态。 <b>1. 充电中:</b> 当电池在充电时, 指示灯显示琥珀色。 <b>2. 完全充电:</b> 当处在 AC 模式时, 指示灯显示蓝色。
		通信指示灯 <sup>1</sup>	根据亮灯情况可检视目前电脑无线连接设备的状态。
9		单击按钮 (左和右)	左右按钮的功能与鼠标的左右键相同。
10		掌垫板	当您使用电脑时, 可舒适支撑手部的区域。
11		扬声器	左右扬声器可提供立体声输出。
12		光驱弹出按钮	按下此按钮可弹出光驱。
13		可编程键	用户可编程 (仅限部分型号)。
		PowerSmart 键	让电脑进入省电模式 (仅限部分型号)。

1. 即使在 LCD 显示屏关闩上也能看到前面板处的状态指示灯。

## 热键

本款电脑提供热键或组合键来实现许多操控，例如：调节屏幕亮度以及音量输出。使用热键时先按住 **<Fn>** 键，然后再按热键组合中的另一个键。

热键	图标	功能	描述
<b>&lt;Fn&gt; + &lt;F3&gt;</b>		通信键	启用 / 禁用电脑的通信设备（通信设备根据配置可能有所不同）。
<b>&lt;Fn&gt; + &lt;F4&gt;</b>		睡眠	让电脑进入睡眠模式。
<b>&lt;Fn&gt; + &lt;F5&gt;</b>		显示屏幕切换	可以在以下三种显示方式间切换：只使用显示屏、只使用已连接的外部显示器、同时使用显示屏和外部显示器。
<b>&lt;Fn&gt; + &lt;F6&gt;</b>		显示屏关闭	关闭显示屏背光以节省电量。按任意键将恢复正常显示。
<b>&lt;Fn&gt; + &lt;F7&gt;</b>		触摸板切换	打开或关闭内置触控板。
<b>&lt;Fn&gt; + &lt;F8&gt;</b>		扬声器切换	打开或关闭扬声器。
<b>&lt;Fn&gt; + &lt;▷&gt;</b>		调高亮度	提高屏幕亮度。
<b>&lt;Fn&gt; + &lt;◁&gt;</b>		调低亮度	调低屏幕亮度。
<b>&lt;Fn&gt; + &lt;△&gt;</b>		调高音量	调高扬声器音量。
<b>&lt;Fn&gt; + &lt;▽&gt;</b>		调低音量	调低扬声器音量。
<b>&lt;Fn&gt; + &lt;Home&gt;</b>		播放 / 暂停	播放或暂停选定媒体文件。
<b>&lt;Fn&gt; + &lt;Pg Up&gt;</b>		停止	停止播放选定媒体文件。
<b>&lt;Fn&gt; + &lt;Pg Dn&gt;</b>		上一个	返回上一个媒体文件。
<b>&lt;Fn&gt; + &lt;End&gt;</b>		下一个	跳至下一个媒体文件。

## 前视图



#	图标	项目	描述
1		多合一读卡器	可支持 Secure Digital (SD)、MultiMediaCard (MMC)、Memory Stick (MS)、Memory Stick PRO (MS PRO)、xD-Picture Card (xD)。 <b>注：</b> 轻推取下 / 安装卡。任何时候，仅支持读取一张卡。

## 右视图

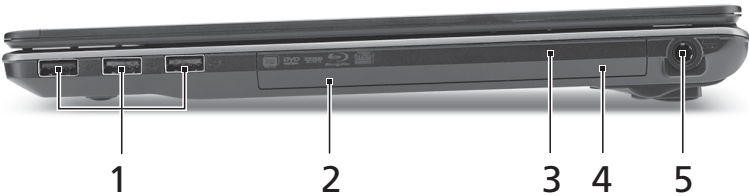

#	图标	项目	描述
1		USB 2.0 端口	连接 USB 2.0 装置 (例如: USB 鼠标、USB 相机)。
2		光驱	内置光驱, 可支持读取 CD 或 DVD。
3		光驱访问指示灯	当光驱被激活时指示灯会亮起。
4		紧急弹出孔	当电脑关闭时, 可弹出光驱托盘。 <b>注：</b> 如果电脑关闭, 请将回形针插入紧急弹出孔, 使光驱弹出。
5		直流电源输入插孔	连接交流适配器。

## 左视图

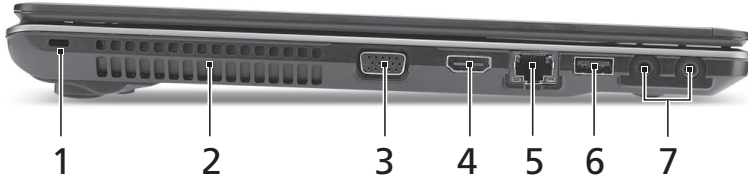





#	图标	项目	描述
1		Kensington 安全锁插槽	连接 Kensington 兼容电脑安全锁。
2		通风槽	可使电脑在长时间使用后仍保持低温。
3		外部显示器 (VGA) 端口	连接显示设备 (例如: 外部显示器、LCD 投影机)。
4		HDMI 端口	支持高清晰数字视频连接。
5		以太网 (RJ-45) 端口	连接 10/100/1000 以太网。
6		USB 2.0 端口	连接 USB 2.0 装置 (例如: USB 鼠标、USB 相机)。
7		麦克风插口	连接外接麦克风。
		支持 S/PDIF 的耳机 / 扬声器 / 音频输出插孔	连接音频输出设备 (例如: 扬声器、耳机)。

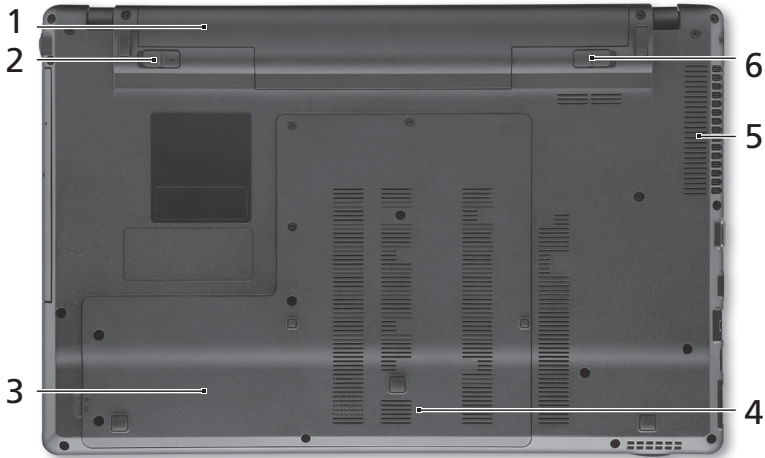

## 底视图



#	图标	项目	描述
1		电池槽	安装电池组。
2		电池锁	可固定锁紧电池组。
3		硬盘槽	安装电脑硬盘的位置（用螺丝紧固）。
4		内存槽	安装电脑主内存的位置。
5		通风槽和冷却风扇	可使电脑在长时间使用后仍保持低温。 <b>注意：</b> 请勿遮挡风扇口。
6		电池释放门锁	释放电池门锁可取下电池组。

## 环境

- 温度：
  - 操作时：5°C 至 35°C
  - 不操作时：-20°C 至 65°C
- 湿度（非冷凝）：
  - 操作时：20% 至 80%
  - 不操作时：20% 至 80%



**注：**上述所列的规格仅供参考。实际规格将视用户实际购买的电脑型号而定。



# Seri Aspire 5745/5553

Panduan cepat

© 2010 Hak Cipta Dilindungi Undang-Undang.

Panduan Cepat Seri Aspire 5745/5553

Edisi Pertama: 03/2010

PC Notebook Seri Aspire 5745/5553

Nomor model: \_\_\_\_\_

Nomor seri: \_\_\_\_\_

Tanggal pembelian: \_\_\_\_\_

Alamat pembelian: \_\_\_\_\_

# Informasi penting

Terima kasih telah memilih notebook Acer untuk memenuhi kebutuhan Anda atas komputer mobile.

## Panduan Anda

Untuk membantu Anda menggunakan notebook Acer, kami menyediakan kumpulan panduan sebagai berikut:

Pertama-tama, brosur **Untuk Pemula...** akan membantu Anda mempersiapkan konfigurasi komputer.

Buku **Panduan Pengguna Generik Seri Aspire** berisi informasi berguna yang berlaku untuk semua model dalam seri produk Aspire. Panduan ini mencakup topik-topik dasar seperti menggunakan keyboard dan, audio, dsb. Mohon dimengerti bahwa karena sifatnya, baik **Panduan Pengguna Generik** maupun **AcerSystem User Guide** yang disebutkan di bawah ini kadang-kadang mengacu pada fungsi-fungsi atau fitur-fitur yang hanya terdapat dalam model-model tertentu dalam seri ini, tetapi tidak terdapat dalam model yang telah Anda beli. Dalam panduan ini, kasus-kasus seperti itu ditandai dengan kalimat seperti "hanya untuk model-model tertentu".

**Panduan cepat** akan menjelaskan fitur dan fungsi dasar komputer baru Anda. Untuk informasi lebih lanjut tentang cara komputer ini membantu Anda agar lebih produktif, lihat **AcerSystem User Guide**. Buku Petunjuk ini berisi informasi rinci tentang topik, seperti utilitas sistem, pemulihan data, berbagai pilihan, dan cara mengatasi masalah. Buku Petunjuk ini juga berisi informasi jaminan serta peraturan umum dan informasi keselamatan untuk notebook Anda. Tersedia dalam PDF (Portable Document Format) dan diberikan sebagai kelengkapan notebook Anda. Ikuti langkah-langkah berikut ini untuk mengaksesnya:

- 1 Klik  **Start > All Programs > AcerSystem.**
- 2 Klik **AcerSystem User Guide.**



.....

**Catatan:** Adobe Reader diperlukan untuk melihat file tersebut. Jika Adobe Reader belum diinstal dalam komputer Anda, klik **AcerSystem User Guide** untuk terlebih dulu menjalankan program konfigurasi Adobe Reader. Untuk menyelesaikan penginstalan, ikuti petunjuk pada layar. Untuk petunjuk tentang cara menggunakan Adobe Reader, akses menu **Help dan Support.**







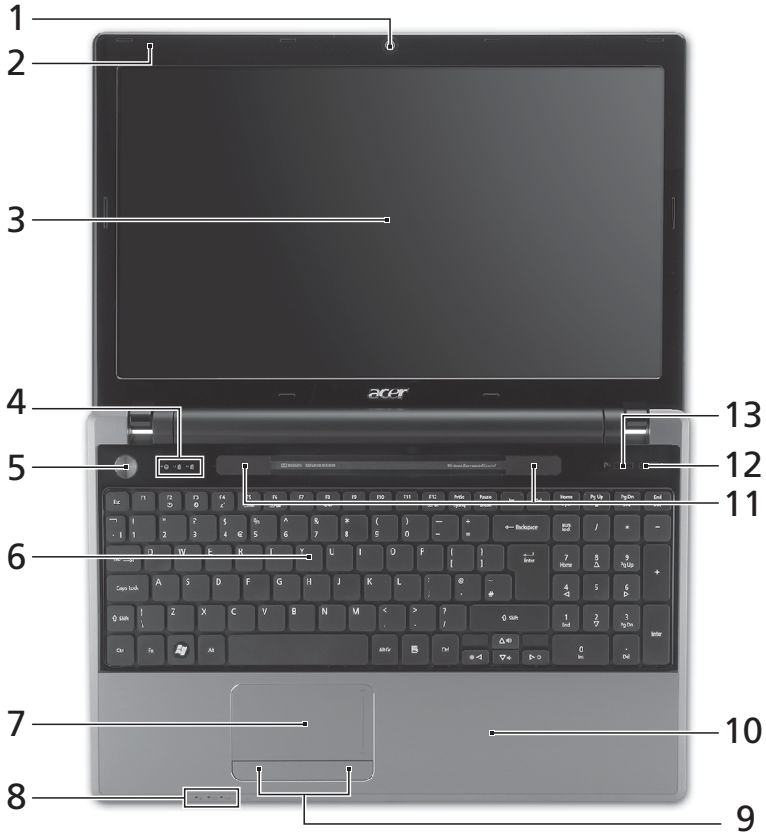

# Tur Acer notebook Anda

Setelah melakukan setup pada komputer Anda sesuai dengan ilustrasi poster, mari kita lihat apa saja yang ada di laptop Acer baru Anda.

## Pandangan atas



#	Ikona	Item	Keterangan
1		Webcam Acer Crystal Eye	Kamera web untuk komunikasi video (hanya untuk model-model tertentu).
2		Mikrofon	Mikrofon internal untuk perekaman suara.















#	Ikon	Item	Keterangan
3		Layar tampilan	Disebut juga sebagai LCD (Liquid-Crystal Display), akan menampilkan output komputer (konfigurasi mungkin berbeda tergantung model).
4		Indikator HDD	Menunjukkan bila drive hard disk aktif.
		Indikator Num Lock	Menyala bila Num Lock diaktifkan.
		Indikator Caps Lock	Menyala bila Caps Lock diaktifkan.
5		Tombol daya	Menghidupkan/mematikan komputer.
6		Keyboard	Untuk memasukkan data ke komputer.
7		Panel sentuh	Perangkat penunjuk sensitif sentuhan yang berfungsi seperti mouse komputer.
8		Indikator daya <sup>1</sup>	Menunjukkan status daya komputer.
		Indikator baterai <sup>1</sup>	Menunjukkan status baterai komputer. <b>1. Mengisi daya:</b> Lampu akan menyala kuning kecokelatan bila daya baterai sedang diisi. <b>2. Daya terisi penuh:</b> Lampu menyala biru bila dalam mode AC.
		Indikator komunikasi <sup>1</sup>	Menunjukkan status perangkat konektivitas nirkabel komputer.
9		Tombol klik (kiri dan kanan)	Tombol kiri dan kanan berfungsi seperti tombol mouse kiri dan kanan.
10		Tempat tangan	Tempat nyaman untuk meletakkan tangan Anda sewaktu menggunakan komputer.
11		Pengeras suara	Pengeras suara kiri dan kanan menghadirkan keluaran audio stereo.
12		Tombol pelepas drive optik	Mengeluarkan disk optik dari drive.
13		Tombol yang dapat diprogram	Dapat diprogram oleh pengguna (hanya untuk model-model tertentu).
		Tombol PowerSmart	Memasukkan komputer Anda ke mode hemat daya (hanya untuk model-model tertentu).

1. Indikator panel depan akan terlihat meskipun penutup komputer dalam keadaan tertutup.

## Tombol pintas

Komputer menggunakan tombol pintas atau kombinasi tombol untuk mengakses sebagian besar kontrol komputer, misalnya kecerahan layar dan output volume suara.

Untuk mengaktifkan tombol pintas, tekan terus tombol **<Fn>** sebelum menekan tombol lain pada kombinasi tombol pintas.

Tombol pintas	Ikon	Fungsi	Keterangan
<b>&lt;Fn&gt; + &lt;F3&gt;</b>		Tombol komunikasi	Mengaktifkan/menonaktifkan perangkat komunikasi komputer (Perangkat komunikasi mungkin berbeda-beda berdasarkan konfigurasinya).
<b>&lt;Fn&gt; + &lt;F4&gt;</b>		Sleep	Mengaktifkan komputer dalam mode Sleep.
<b>&lt;Fn&gt; + &lt;F5&gt;</b>		Toggle layar	Mengalihkan output tampilan antara layar tampilan, monitor eksternal (jika dipasang), dan keduanya.
<b>&lt;Fn&gt; + &lt;F6&gt;</b>		Tampilan mati	Menonaktifkan cahaya latar layar tampilan untuk menghemat daya. Tekan tombol apa saja untuk kembali.
<b>&lt;Fn&gt; + &lt;F7&gt;</b>		Tombol panel sentuh	Mengaktifkan dan menonaktifkan panel sentuh internal.
<b>&lt;Fn&gt; + &lt;F8&gt;</b>		Tombol speaker	Mengaktifkan dan menonaktifkan speaker.
<b>&lt;Fn&gt; + &lt;▷&gt;</b>		Kecerahan meningkat	Meningkatkan kecerahan layar.
<b>&lt;Fn&gt; + &lt;◁&gt;</b>		Kecerahan berkurang	Mengurangi kecerahan layar.
<b>&lt;Fn&gt; + &lt;△&gt;</b>		Volume naik	Menaikkan volume.
<b>&lt;Fn&gt; + &lt;▽&gt;</b>		Volume turun	Menurunkan volume.
<b>&lt;Fn&gt; + &lt;Home&gt;</b>		Putar/Jeda	Memutar atau menjeda file media yang dipilih.
<b>&lt;Fn&gt; + &lt;Pg Up&gt;</b>		Berhenti	Menghentikan pemutaran file media yang dipilih.
<b>&lt;Fn&gt; + &lt;Pg Dn&gt;</b>		Sebelumnya	Kembali ke file media sebelumnya.
<b>&lt;Fn&gt; + &lt;End&gt;</b>		Berikutnya	Lompat ke file media berikutnya.



## Tampilan depan (tertutup)



#	Ikun	Item	Keterangan
1		Pembaca kartu Multi-in-1	<p>Menerima Secure Digital (SD), MultiMediaCard (MMC), Memory Stick (MS), Memory Stick PRO (MS PRO), xD-Picture Card (xD).</p> <p><b>Catatan:</b> Tekan untuk melepas/memasang kartu. Hanya satu kartu yang bisa beroperasi saat Anda menggunakannya.</p>



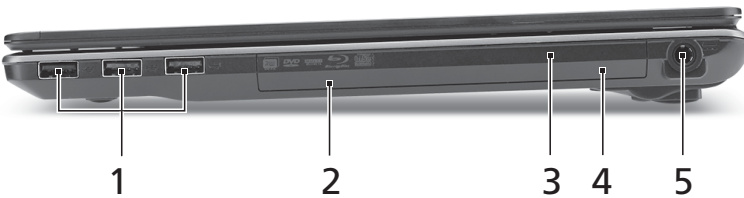



## Pandangan kanan

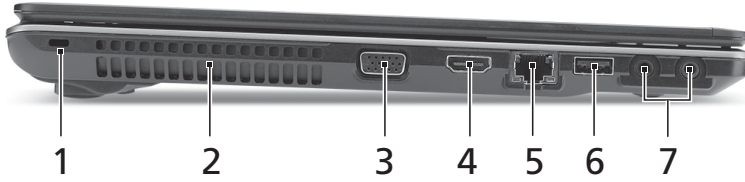

#	Ikun	Item	Keterangan
1		Port USB 2.0	Menghubungkan ke perangkat USB 2.0 (misalnya, mouse USB, kamera USB).
2		Drive optik	Drive optik internal; menerima CD atau DVD.
3		Indikator akses disket optik	Menyala saat drive optik aktif.
4		Lubang pelepas darurat	Melepas tempat drive optik saat komputer mati. <b>Catatan:</b> Masukkan klip kertas ke lubang pengeluaran darurat untuk mengeluarkan tray drive optik bila komputer mati.
5		Jack DC-in	Menghubungkan ke Adaptor AC.





## Pandangan kiri

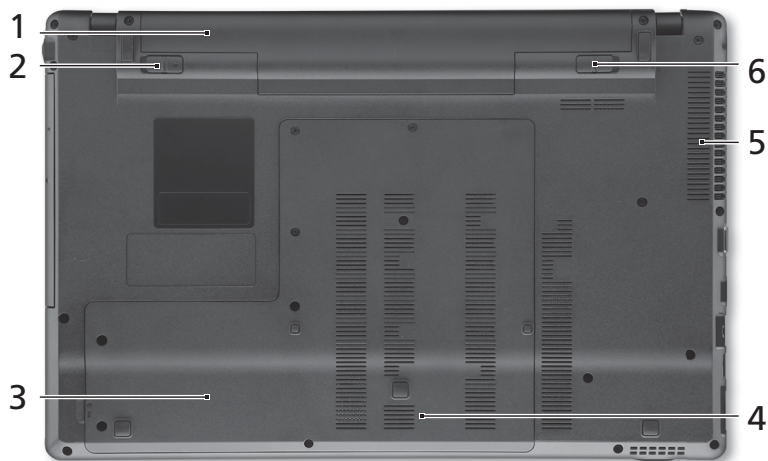

#	Ikon	Item	Keterangan
1		Slot kunci Kensington	Menghubungkan ke kunci keamanan komputer yang kompatibel dengan kunci Kensington.
2		Slot ventilasi	Membuat komputer tetap dingin, bahkan setelah pemakaian yang lama.
3		Port tampilan (VGA) eksternal	Menghubungkan perangkat tampilan (mis., monitor eksternal, proyektor LCD).
4		Port HDMI	Mendukung koneksi video digital definisi tinggi.
5		Port ethernet (RJ-45)	Menghubungkan ke jaringan berbasis ethernet 10/100/1000.
6		Port USB 2.0	Menghubungkan ke perangkat USB 2.0 (misalnya, mouse USB, kamera USB).
7		Jack mikrofon	Menerima input dari mikrofon eksternal.
		Port headphone/speaker/saluran output dengan dukungan S/PDIF	Menghubungkan ke perangkat sambungan keluar audio (mis. penguat suara, headphone).

## Tampilan bawah



#	Ikon	Item	Keterangan
1		Tempat baterai	Tempat kemasan baterai komputer.
2		Kunci baterai	Mengunci baterai pada tempatnya.
3		Bay hard disk	Untuk memasang hard disk komputer (dipasang dengan sekrup).
4		Kompartemen memori	Untuk memasang memori utama komputer.
5		Slot ventilasi dan kipas pendingin	Membuat komputer tetap dingin, bahkan setelah pemakaian yang lama. <b>Catatan:</b> Lubang kipas jangan sampai tertutup atau terhalang.
6		Penutup pelepas baterai	Untuk melepaskan baterai.

## Lingkungan

---

- Suhu:
    - Beroperasi: 5°C hingga 35°C
    - Tidak beroperasi: -20°C hingga 65°C
  - Kelembaban (non-kondensasi):
    - Beroperasi: 20% hingga 80%
    - Tidak beroperasi: 20% hingga 80%
- 



.....

**Catatan:** Spesifikasi yang tertera di atas hanya sebagai referensi. Konfigurasi yang pasti untuk PC Anda bergantung pada model yang Anda beli.

ซีรีส์ Aspire 5745/5553

คู่มืออย่างย่อ

© 2010 สงวนลิขสิทธิ์

คู่มืออย่างย่อ ซีรีส์ Aspire 5745/5553  
คนฉบับ: 03/2010

โน้ตบุ๊กพีซี ซีรีส์ Aspire 5745/5553

หมายเลขรุ่น: \_\_\_\_\_

ซีเรียลนัมเบอร์: \_\_\_\_\_

วันที่ซื้อ: \_\_\_\_\_

สถานที่ซื้อ: \_\_\_\_\_

# สิ่งสำคัญอันดับแรก

ขอขอบคุณที่คุณเลือกโน้ตบุ๊กจาก Acer เพื่อรองรับการใช้งานแบบพกพาของคุณ

## คู่มือสำหรับคุณ

เพื่อช่วยสอนการใช้โน้ตบุ๊ก Acer เราจึงได้จัดทำคู่มือชุดนี้ขึ้น

เริ่มจากไปเสเตอร์ **ข้อมูลสำหรับผู้เริ่มต้นใช้งาน** เพื่อแนะนำเกี่ยวกับการติดตั้งคอมพิวเตอร์เบื้องต้น

**คู่มือผู้ใช้ทั่วไปสำหรับโน้ตบุ๊กรุ่น Aspire** ประกอบไปด้วยข้อมูลที่เป็นประโยชน์สำหรับผลิตภัณฑ์ตระกูล Aspire ทุกรุ่น โดยระบุรายการทำงานเบื้องต้นต่าง ๆ เช่น การใช้คีย์บอร์ด ระบบเสียง ฯลฯ

เนื่องจากการจัดทำคู่มือแบบครอบคลุมรวม **คู่มือผู้ใช้ทั่วไป** และ **AcerSystem User Guide** ซึ่งจะกล่าวถึงต่อไปนี้อาจมีฟังก์ชันหรือคุณสมบัติต่าง ๆ ที่มีอยู่เฉพาะในผลิตภัณฑ์บางรุ่นเท่านั้น ซึ่งอาจไม่รวมถึงผลิตภัณฑ์รุ่นที่คุณจัดซื้อ กรณีเช่นนี้จะมีแจ้งให้ทราบโดยระบุเป็นข้อความต่าง ๆ เช่น “เฉพาะบางรุ่นเท่านั้น”

**คู่มืออย่างย่อ** เป็นข้อมูลคุณสมบัติและฟังก์ชันเบื้องต้นในคอมพิวเตอร์เครื่องใหม่ของคุณ สอบถามข้อมูลการใช้งานคอมพิวเตอร์เพื่อให้เกิดประสิทธิภาพสูงสุดได้จาก **AcerSystem User Guide** คู่มือชุดนี้ประกอบไปด้วยข้อมูลโดยละเอียดในเรื่องต่าง ๆ เช่น ยูทิลิตี้ การเรียกคืนข้อมูล การติดตั้งส่วนประกอบเพิ่มเติมและการแก้ไขปัญหา นอกจากนี้ยังมีข้อมูลการรับประกัน หลักเกณฑ์ทั่วไปและข้อมูลด้านความปลอดภัยสำหรับโน้ตบุ๊กของคุณ แฟ้มข้อมูลจัดทำเป็นไฟล์ Portable Document Format (PDF) ซึ่งติดตั้งสำเร็จในโน้ตบุ๊กของคุณ เรียกค้นได้โดยทำตามขั้นตอนต่อไปนี้

- 1 คลิกที่  **Start > All Programs > AcerSystem**
- 2 คลิกที่ **AcerSystem User Guide**





**หมายเหตุ:** คุณต้องมี Adobe Reader เพื่อเปิดดูไฟล์ ในกรณีที่ไม่มีได้ติดตั้ง Adobe Reader ไว้ในคอมพิวเตอร์ กรุณาคลิกที่ **AcerSystem User Guide** จากนั้นโปรแกรมติดตั้ง Adobe Reader จะเปิดขึ้น ทำตามคำแนะนำบนหน้าจอเพื่อดำเนินการติดตั้งให้เสร็จสิ้น ดูคำแนะนำในการใช้ Adobe Reader ได้จากเมนู **Help and Support**

# แนะนำเกี่ยวกับโน้ตบุ๊ก Acer ของคุณ

หลังจากติดตั้งคอมพิวเตอร์ตามภาพในโปสเตอร์ ต่อไปนี้เป็นวิธีการใช้งานโน้ตบุ๊ก Acer ใหม่ของคุณ

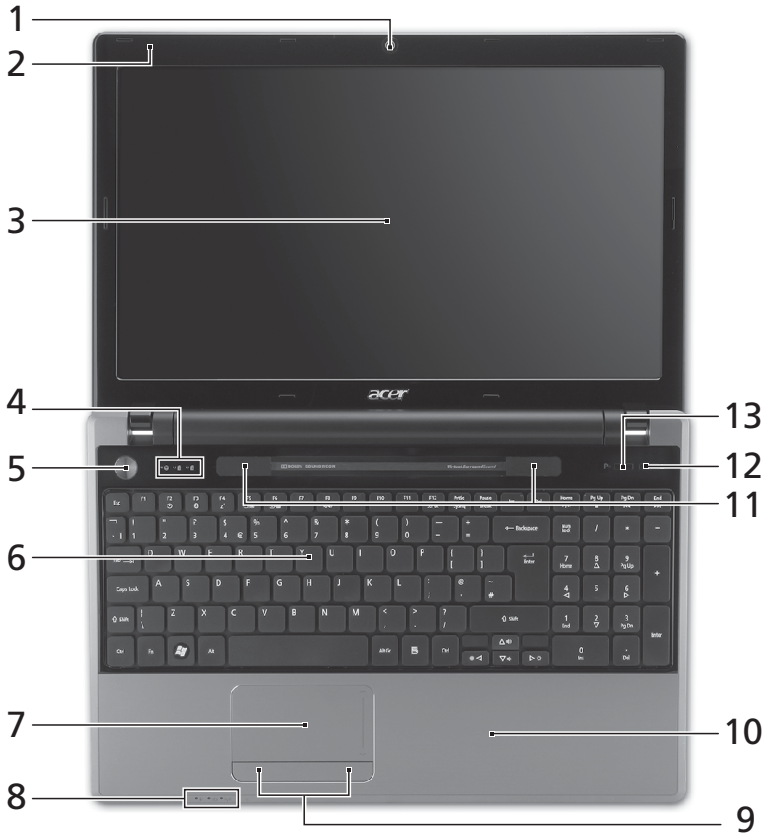
## มุมมองด้านบน



#	ไอคอน	รายการ	คำอธิบาย
1		เว็บแคม Acer Crystal Eye	กล้องเว็บแคมสำหรับระบบการสื่อสารด้วยวิดีโอ (เฉพาะบางรุ่นเท่านั้น)
2		ไมโครโฟน	ไมโครโฟนในตัวสำหรับบันทึกเสียง



#	ไอคอน	รายการ	คำอธิบาย
3		จอแสดงผล	หรือ Liquid-Crystal Display (LCD) ใช้แสดงข้อมูลต่างๆ ของคอมพิวเตอร์ (ส่วนประกอบอาจแตกต่างกันไปตามรุ่น)
4		ตัวแสดงสถานะ HDD	แสดงเมื่อฮาร์ดดิสก์ไดรฟ์มีการทำงาน
		ไฟแสดงสถานะ Num Lock	ติดสว่างในกรณีที่ใช้ Num Lock
		ไฟแสดงสถานะ Caps Lock	ไฟสว่างเมื่อเปิดใช้งาน Caps Lock
5		ปุ่มเปิดปิด	เปิดและปิดคอมพิวเตอร์
6		คีย์บอร์ด	เพื่อป้อนข้อมูลเข้าสู่คอมพิวเตอร์ของคุณ
7		ทัชแพด	อุปกรณ์ชี้ตำแหน่งแบบสัมผัส ซึ่งทำงานแบบเดียวกับเมาส์คอมพิวเตอร์
8		ตัวแสดงพลังงาน <sup>1</sup>	ระบุสถานะการเปิดใช้งานคอมพิวเตอร์
		ตัวแสดงระดับแบตเตอรี่ <sup>1</sup>	แสดงถึงสถานะแบตเตอรี่ของคอมพิวเตอร์ <b>1. กำลังชาร์จ:</b> ไฟสว่างเป็นสีเหลืองอำพันเมื่อทำการชาร์จแบตเตอรี่ <b>2. ชาร์จไฟเต็ม:</b> ไฟสีน้ำเงินติดสว่างขณะอยู่ในโหมด AC
		ไฟแสดงสถานะการสื่อสาร <sup>1</sup>	แสดงถึงสถานะอุปกรณ์เชื่อมต่อแบบไร้สายของคอมพิวเตอร์
9		ปุ่มคลิก (ซ้ายและขวา)	ปุ่มซ้ายและขวาทำงานเหมือนกับปุ่มเมาส์ซ้ายและขวา
10		ที่วางมือ	พื้นที่รองรับมือเพื่อให้รู้สึกสบายขณะใช้คอมพิวเตอร์
11		ลำโพง	ลำโพงซ้ายและขวาเพื่อจ่ายสัญญาณเสียงระบบสเตอริโอ
12		ปุ่มกดแผ่นออฟติคอลลูกออก	นำแผ่นออฟติคอลลูกออกจากไดรฟ์
13	<b>P</b>	ปุ่มที่สามารถตั้งโปรแกรมได้	ผู้ใช้สามารถตั้งโปรแกรมได้ (เฉพาะบางรุ่นเท่านั้น)
		ปุ่ม PowerSmart	สั่งการคอมพิวเตอร์เข้าสู่โหมดประหยัดพลังงาน (เฉพาะบางรุ่นเท่านั้น)

1. สัญลักษณ์ที่แฉงด้านหน้าสามารถมองเห็นได้แม้ขณะปิดฝาพับคอมพิวเตอร์

## ปุ่มลัด

คอมพิวเตอร์จะมีคีย์ลัดหรือชุดแป้นกดเพื่อเข้าใช้งานส่วนควบคุมต่าง ๆ ของคอมพิวเตอร์ เช่น ความสว่างของหน้าจอและระดับเสียง

เพื่อเปิดใช้งานฮ็อตคีย์ ให้กดปุ่ม **<Fn>** ค้างเอาไว้ก่อนที่จะกดปุ่มอื่นในชุดฮ็อตคีย์

ฮ็อตคีย์	ไอคอน	ฟังก์ชัน	คำอธิบาย
<b>&lt;Fn&gt; + &lt;F3&gt;</b>		ปุ่มการสื่อสาร	เปิด/ปิด อุปกรณ์สื่อสารของคอมพิวเตอร์ (อุปกรณ์สื่อสารอาจแตกต่างกันขึ้นอยู่กับรูปแบบการติดตั้งใช้งาน)
<b>&lt;Fn&gt; + &lt;F4&gt;</b>		สลีป	ตั้งคอมพิวเตอร์ให้อยู่ในโหมดสลีป
<b>&lt;Fn&gt; + &lt;F5&gt;</b>		สลีบจอแสดงผล	สลีบเอาที่พู่จอแสดงผลระหว่างหน้าจอแสดงผล, จอแสดงผลภายนอก (หากเชื่อมต่ออยู่) และทั้งสองชนิด
<b>&lt;Fn&gt; + &lt;F6&gt;</b>		ปิดการแสดงผล	ปิดไฟพื้นหลังจอแสดงผลเพื่อประหยัดพลังงาน กดปุ่มใดก็ได้เพื่อเปิดหน้าจอกลับมามีอีกครั้ง
<b>&lt;Fn&gt; + &lt;F7&gt;</b>		สวิตช์เปิดปิดแป้นสัมผัส	เปิดและปิดทัชแพดบนเครื่อง
<b>&lt;Fn&gt; + &lt;F8&gt;</b>		เปิดปิดลำโพง	เปิดและปิดลำโพง
<b>&lt;Fn&gt; + &lt;▷&gt;</b>		เพิ่มความสว่าง	เพิ่มความสว่างของหน้าจอ
<b>&lt;Fn&gt; + &lt;◁&gt;</b>		ลดความสว่าง	ลดความสว่างของหน้าจอ
<b>&lt;Fn&gt; + &lt;△&gt;</b>		เพิ่มเสียง	เพิ่มระดับเสียง
<b>&lt;Fn&gt; + &lt;▽&gt;</b>		ลดเสียง	ลดระดับเสียง
<b>&lt;Fn&gt; + &lt;Home&gt;</b>		เล่น/หยุดเล่น	เล่นหรือหยุดเล่นไฟล์มีเดียชั่วคราว
<b>&lt;Fn&gt; + &lt;Pg Up&gt;</b>		หยุด	หยุดการเล่นไฟล์มีเดีย
<b>&lt;Fn&gt; + &lt;Pg Dn&gt;</b>		ก่อนหน้า	กลับสู่ไฟล์มีเดียก่อนหน้า
<b>&lt;Fn&gt; + &lt;End&gt;</b>		ถัดไป	ไปสู่อไฟล์มีเดียถัดไป

## ปิดมุมมองด้านบน



#	ไอคอน	รายการ	คำอธิบาย
1		การ์ดรีดเดอร์ Multi-in-1	สามารถใช้งานร่วมกับ Secure Digital (SD), MultiMediaCard (MMC), Memory Stick (MS), Memory Stick PRO (MS PRO), xD-Picture Card (xD) <b>หมายเหตุ:</b> กดเพื่อถอดใส่การ์ด ใช้งานการ์ดได้ครั้งละหนึ่งชุดเท่านั้น



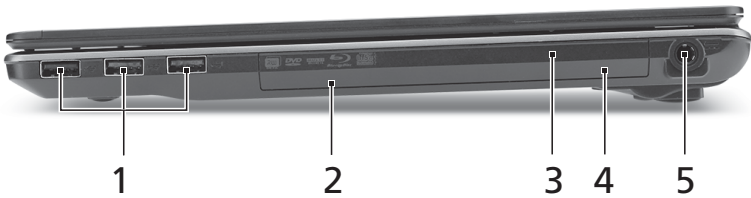



## มุมมองด้านขวา

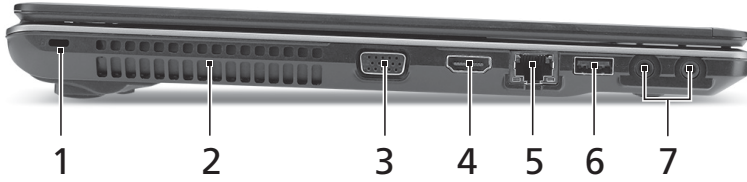

#	ไอคอน	รายการ	คำอธิบาย
1		พอร์ต USB 2.0	ต่ออุปกรณ์ USB 2.0 (เช่น เมาส์หรือกล้อง USB)
2		ไดรฟ์ออปติคัล	ไดรฟ์ออปติคัลภายใน สำหรับใส่ CD หรือ DVD
3		ไฟแสดงการอ่านออปติคัลดิสก์	ติดสว่างเมื่อมีการอ่านแผ่นออปติคัล
4		ปุ่มนำแผ่นออกจุกเงิน	ใช้เปิดถาดใส่แผ่นออปติคัลขณะปิดคอมพิวเตอร์ <b>หมายเหตุ:</b> สอดคียบัตรหน่วยความจำในช่องนำแผ่นออกจุกเงิน เพื่อเปิดถาดใส่แผ่นออปติคัลขณะปิดคอมพิวเตอร์อยู่
5		ช่องเสียบ DC-in	เชื่อมต่อกับแอดปเตอร์ AC



## มุมมองด้านซ้าย

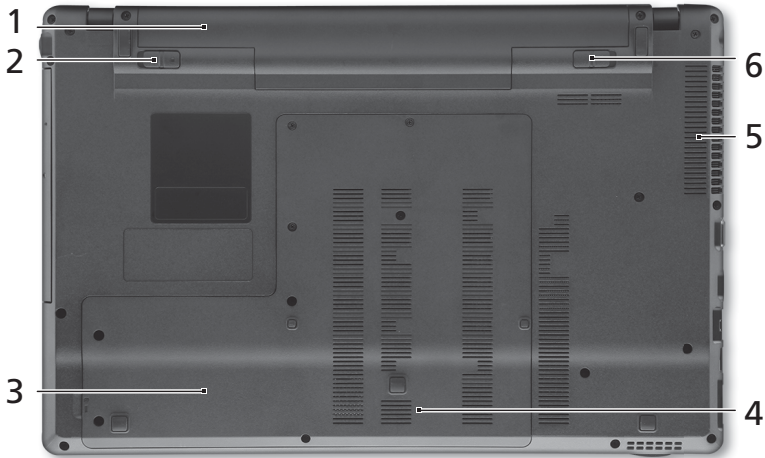

#	ไอคอน	รายการ	คำอธิบาย
1		สล๊อคตัลล็อก Kensington	เชื่อมต่อกับระบบล็อกความปลอดภัยสำหรับคอมพิวเตอร์ที่มีความเข้ากันได้กับ Kensington
2		ช่องระบายอากาศ	ช่วยให้คอมพิวเตอร์เย็น แม้หลังจากใช้งานเป็นเวลานาน
3		พอร์ตจอแสดงผลต่อพ่วง (VGA)	เชื่อมต่อกับจอแสดงผล (เช่น จอภาพภายนอก, โปรเจคเตอร์ LCD)
4		พอร์ต HDMI	รองรับการเชื่อมต่อระบบวิดีโอดิจิทัลความละเอียดสูง
5		พอร์ต Ethernet (RJ-45)	เชื่อมต่อเครือข่าย Ethernet 10/100/1000
6		พอร์ต USB 2.0	ต่ออุปกรณ์ USB 2.0 (เช่น เม้าส์หรือกล้อง USB)
7		ช่องเสียบไมโครโฟน	ใช้สำหรับต่อไมโครโฟน
		ช่องเสียบหูฟัง/ลำโพง/ SPDIF line-out รองรับ S/PDIF	ใช้สำหรับต่ออุปกรณ์เสียงขาออก (เช่น ลำโพง ชุดหูฟัง)

## มุมมองด้านล่าง



#	ไอคอน	รายการ	คำอธิบาย
1		ช่องใส่แบตเตอรี่	ใช้สำหรับเก็บแพ็คแบตเตอรี่ของคอมพิวเตอร์
2		ล็อกแบตเตอรี่	ล็อกแบตเตอรี่ให้อยู่ในตำแหน่ง
3		ช่องใส่ฮาร์ดดิสก์	ที่อยู่ของฮาร์ดดิสก์ของคอมพิวเตอร์ (ยึดติดแน่นด้วยนอต)
4		ช่องหน่วยความจำ	ที่อยู่ของหน่วยความจำของคอมพิวเตอร์
5		สล็อตอุปกรณ์ระบายอากาศ และพัดลมระบายความร้อน	ช่วยให้คอมพิวเตอร์เย็น แม้หลังจากใช้งานเป็นเวลานาน <b>หมายเหตุ:</b> ห้ามปิดทางช่องเปิดสำหรับพัดลม
6		สลักปลดล็อกแบตเตอรี่	ปลดล็อกเพื่อนำแบตเตอรี่ออก

## สิ่งแวดล้อม

- อุณหภูมิ:
  - ขณะทำงาน: 5°C ถึง 35°C
  - ขณะไม่ได้ใช้งาน: -20°C ถึง 65°C
- ความชื้น (ไม่ควบนั่นเป็นไอน้ำ):
  - ขณะทำงาน: 20% ถึง 80%
  - ขณะไม่ได้ใช้งาน: 20% ถึง 80%



หมายเหตุ: รายละเอียดทางเทคนิคที่แจ้งข้างต้นจัดให้เป็นข้อมูลอ้างอิงเท่านั้น ส่วนประกอบที่แน่นชัดของเครื่องพีซีของคุณจะขึ้นอยู่กับรุ่นที่จัดซื้อ